

# Operating Instructions

**8 kW 220 V**

**Selectiva**

**4120 / 4140 / 4160**

**8 kW 400 V**

**Selectiva**

**2100 / 2120 / 2140**

**2160 / 2180 / 2200**

**4060 / 4075 / 4090**

**4120 / 4140 / 4160**

**8040 / 8060 / 8075**

**8090**

**16 kW 400 V**

**Selectiva**

**8120 / 8140 / 8160**

**8180 / 8210**

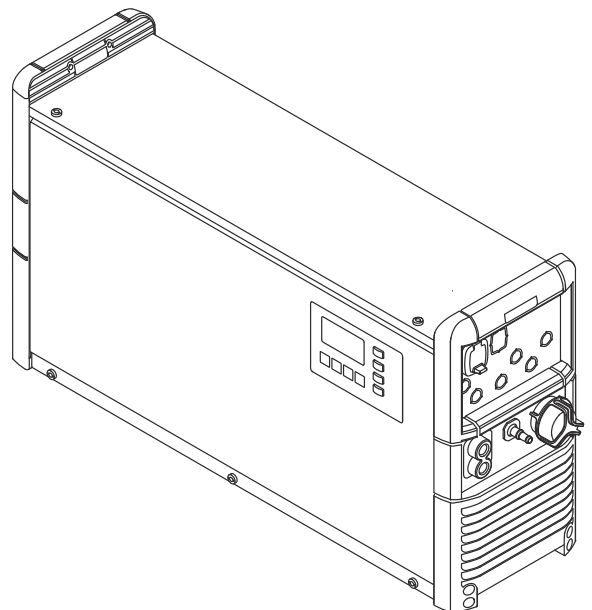



# Contents

Safety rules.....	5
General.....	5
Intended use.....	5
Environmental conditions.....	5
Mains connection.....	6
Dangers due to grid and charging current.....	6
Danger due to acid, gases and vapours.....	6
General information on working with batteries.....	7
Personal protection and protection of others.....	7
Safety measures in normal operation.....	7
EMC Device Classifications.....	7
EMC measures.....	8
Data security.....	8
Maintenance.....	8
Repair.....	8
Obligations of the operator.....	8
Safety inspection.....	8
Markings on the device.....	9
Disposal.....	9
Copyright.....	9
General information.....	10
Explanation of safety notices.....	10
Device concept.....	10
Battery configuration.....	10
Mains connection.....	11
Charging lead.....	11
Warning notices on the device.....	11
Warning notices inside the device.....	13
Setup regulations.....	14
Wall bracket.....	15
Correct installation of the mains/charging cables.....	19
Control elements and connections.....	20
Controls and connections.....	20
Control panel.....	21
Charging the battery.....	23
Charging.....	23
Interrupting charging.....	24
Stopping charging.....	25
Display.....	27
Overview of display modes.....	27
Standard mode.....	27
Menu selection.....	28
Statistics mode.....	28
History mode.....	28
Configuration mode.....	30
Overview of charging settings.....	33
Electrolyte circulation.....	34
Temperature-controlled charging.....	34
Equalising charge.....	35
Delay.....	36
Calendar.....	37
Special charges.....	39
“Opportunity Charge” special function.....	39
Additional functions.....	40
General settings.....	43
Reset settings.....	45
USB mode.....	45
Status codes.....	47
Options.....	53
Safety.....	53

Electrolyte circulation (not available with Selectiva 3x220 16 kW variants).....	53
External start/stop.....	54
Charging lights.....	54
Temperature-controlled charging.....	55
CAN card.....	55
Relay board.....	56
Aquamatic control.....	57
Charging.....	57
Charge 50%.....	57
Charge 80%.....	57
Charging not complete.....	57
Charge finish.....	58
Main charge finished.....	58
Common error message.....	58
Common error + warning.....	58
Signal lamp.....	58
Immobiliser device.....	58
Battery cooled down.....	58
External air pump - electrolyte circulation.....	58
Wall bracket.....	58
Floor bracket.....	59
LED strip.....	59
IP 23.....	59
Air filter.....	59
"Mobile" kit.....	59
Remote control system.....	59
Technical data.....	60
Selectiva 16 kW 220 V.....	60
Selectiva 8 kW 400 V.....	62
Selectiva 16 kW 400 V.....	64

# Safety rules

---

## General

The device has been manufactured in line with the state of the art and according to recognized safety standards. If used incorrectly or misused, however, it can cause:

- Serious or fatal injury to the operator or third parties
  - Damage to the device and other material assets belonging to the operating company
  - Inefficient operation of the device
- 

All persons involved in the commissioning, operation, maintenance, and servicing of the device must:

- Be suitably qualified
  - Have fully read and precisely followed these Operating Instructions
- 

The Operating Instructions must always be kept to hand wherever the device is being used. In addition to the Operating Instructions, all applicable local rules and regulations regarding accident prevention and environmental protection must also be followed.

---

All safety and danger notices on the device:

- Must be kept in a legible state
  - Must not be damaged
  - Must not be removed
  - Must not be covered, pasted, or painted over
- 

For the location of the safety and danger notices on the device, refer to the section headed "General information" in the Operating Instructions for the device. Before switching on the device, eliminate any faults that could compromise safety.

**Your personal safety is at stake!**

---

## Intended use

The device is to be used exclusively for its intended purpose. Any use above and beyond this purpose is deemed improper. The manufacturer is not liable for any damage, or unexpected or incorrect results arising out of such misuse.

---

Proper use also includes:

- Carefully reading and following all Operating Instructions, safety and danger notices
  - Performing all stipulated inspection and servicing work
  - Following all instructions from the battery and vehicle manufacturers
- 

Proper handling of the device is essential for it to function correctly. Never pull on the cable when handling the device.

---

## Environmental conditions

Operation or storage of the device outside the stipulated area will be deemed as not in accordance with the intended purpose. The manufacturer shall not be held liable for any damage arising from such usage.

---

For exact information on permitted environmental conditions, please refer to the "Technical data" section.

---

**Mains connection**

Devices with a higher rating may affect the energy quality of the mains due to their current consumption.

---

This may affect a number device types in terms of:

- Connection restrictions
- Criteria with regard to the maximum permissible mains impedance <sup>\*)</sup>
- Criteria with regard to the minimum short-circuit power requirement <sup>\*)</sup>

<sup>\*)</sup> at the interface with the public grid  
see "Technical data"

---

In this case, the plant operator or the person using the device should check whether the device may be connected, where appropriate by discussing the matter with the power supply company.

---

**IMPORTANT!** Ensure that the mains connection is earthed properly

The mains voltage tolerances of the devices may deviate from those specified in the technical data depending on the mains connection.

---

**Dangers due to grid and charging current**

Working with battery chargers poses a number of dangers, such as:

- Electrical hazard due to grid and charging current
- Hazardous electromagnetic fields that may pose a risk of death for individuals with pacemakers.

---

An electric shock can be fatal. Every electric shock poses a risk of death. To prevent electric shock during operation:

- Do not touch any voltage-carrying parts inside or outside of the device.
- Never touch the battery poles.
- Do not short-circuit the charging cable or charging terminals.

---

All cables and leads must be secured, undamaged, insulated, and adequately dimensioned. Loose connections, scorched, damaged, or under-dimensioned cables and leads must be repaired immediately by an authorized specialist.

---

**Danger due to acid, gases and vapours**

Batteries contain acids which pose a risk to the eyes and skin. Furthermore, charging batteries produces gases and vapors that may be hazardous to your health and are highly explosive under certain circumstances.

---

Only use battery chargers in well ventilated rooms in order to prevent the accumulation of explosive gases. Battery charging rooms are not considered at risk of explosion if a hydrogen concentration of less than 4 % is guaranteed by natural or artificial ventilation.

---

During charging, observe a minimum distance of 0.5 m (19.69 in.) between the battery and battery charger. Keep potential sources of ignition such as fire and open flames away from the battery.

---

Never disconnect the battery (e.g., charging terminals) during charging.

---

Never breathe in the gases and vapors produced by the battery – ensure there is a sufficient supply of fresh air.

---

Do not place any tools or electrically conductive metals on the battery, in order to prevent short circuits.

---

Never allow battery acid to come into contact with your eyes, skin, or clothing. Wear eye protection and appropriate protective clothing. Rinse away any

splashed acid immediately and thoroughly with clean water, and consult a physician if necessary.

---

**General information on working with batteries**

- Protect batteries from dirt and mechanical damage.
  - Store charged batteries in cool rooms. The lowest self discharge occurs at approx. +2°C (35.6°F).
  - Refer to the specifications of the battery manufacturer or conduct weekly visual inspections to ensure that the battery is filled with acid (electrolyte) up to the maximum marking.
  - Do not start operating the device, or immediately stop operation, and have the battery inspected by an authorized specialist if:
    - The acid level is uneven or there is high water consumption in individual cells caused by a possible defect
    - The battery heats up to an impermissible level, above 55°C (131°F)
- 

**Personal protection and protection of others**

- Keep persons, especially children, away from the device and working area during operation. However, if persons are in the vicinity:
- Inform them of any dangers (hazardous acids and gases, risk due to grid and charging current, etc.),
  - Provide suitable protective equipment.

Before leaving the working area, ensure that no personal injury or property damage can occur in your absence.

---

**Safety measures in normal operation**

Operate devices with ground conductors only on a grid with a ground conductor and a socket with a ground conductor contact. Operating the device on a grid without a ground conductor or on a socket without a ground conductor contact is considered gross negligence. The manufacturer accepts no liability for any damage resulting from improper use.

---

Only operate the device in accordance with the protection class shown on the rating plate.

---

Never commission the device if it is damaged.

---

Have the grid and device supply lead regularly inspected by an electrician to ensure that the ground conductor is functioning properly.

---

Safety devices that are not fully functional and components with defects must be repaired by an authorized specialist before the device is turned on.

---

Never bypass or disable protection devices.

---

A freely accessible mains plug is required after installation.

---

**EMC Device Classifications**

Devices in emission class A:

- Are only designed for use in industrial settings
  - Can cause line-bound and radiated interference in other areas
- 

Devices in emission class B:

- Satisfy the emissions criteria for residential and industrial areas. This is also true for residential areas in which the energy is supplied from the public low-voltage mains.
-

EMC device classification as per the rating plate or technical data.

---

**EMC measures** In certain cases, even though a device complies with the standard limit values for emissions, it may affect the application area for which it was designed (e.g. when there is sensitive equipment at the same location, or if the site where the device is installed is close to either radio or television receivers).  
If this is the case, then the operating company is obliged to take appropriate action to rectify the situation.

---

**Data security** With regard to data security, the user is responsible for:

- backing up any changes made to the factory settings
- saving and retaining personal settings

---

**Maintenance** Before each start-up, check the mains plug and mains cable and charging cables and charging terminals for damage.  
If dirt accumulates on the device, clean the surface of the device housing with a soft cloth and only with solvent-free cleaning agents.

---

**Repair** Repair work must only be carried out by authorised personnel. Use only original spare and wearing parts (also applies to standard parts). It is impossible to guarantee that bought-in parts are designed and manufactured to meet the demands made on them, or that they satisfy safety requirements.

---

Modifications, installations or conversions are only permitted with the approval of the manufacturer.

---

**Obligations of the operator** The operator must only allow persons to work with the device who:

- are familiar with the fundamental instructions regarding safety at work and accident prevention and have been instructed in how to use the device
- have read and understood these operating instructions, especially the section "safety rules", and have confirmed as much with their signatures
- are trained to produce the required results.

---

Checks must be carried out at regular intervals to ensure that operators are working in a safety-conscious manner.

---

**Safety inspection** The manufacturer recommends that a safety inspection of the device is performed at least once every 12 months.

---

The safety inspection may only be performed by an appropriately qualified electrician

- After any changes have been made
- After any additional parts are installed, or after any conversions
- After repair, care and maintenance are carried out
- At least every twelve months

---

For safety inspections, follow the appropriate national and international standards and directives.

---



Further details on safety inspections can be obtained from your service centre. They will provide you on request with any documents you may require.

---

**Markings on the device**

Devices with the CE marking satisfy the essential requirements of the applicable guidelines.

---

Devices displaying the EAC mark of conformity satisfy the requirements of the relevant standards in Russia, Belarus, Kazakhstan, Armenia and Kyrgyzstan.

---

**Disposal**

Waste electrical and electronic equipment must be collected separately and recycled in an environmentally responsible manner in accordance with the EU Directive and national law. Used equipment must be returned to the distributor or through a local, authorised collection and disposal system. Correct disposal of the used device promotes sustainable recycling of resources and prevents negative effects on health and the environment.

**Packaging materials**

- Collect separately
  - Observe locally valid regulations
  - Compress the cardboard box to reduce volume
- 

**Copyright**

Copyright of these operating instructions remains with the manufacturer.

---

Text and illustrations were accurate at the time of printing, subject to change. We are grateful for suggestions for improvement and information regarding any discrepancies in the operating instructions.

# General information

---

## Explanation of safety notices

### **DANGER!**

**Indicates immediate danger.**

- ▶ If not avoided, death or serious injury will result.
- 

### **WARNING!**

**Indicates a potentially hazardous situation.**

- ▶ If not avoided, death or serious injury may result.
- 

### **CAUTION!**

**Indicates a situation where damage or injury could occur.**

- ▶ If not avoided, minor injury and/or damage to property may result.
- 

### **NOTE!**

**Indicates a risk of flawed results and possible damage to the equipment.**

---

## Device concept

The battery chargers are characterized by intelligent charging technology. The Active Inverter Technology with the Ri charging process adapts to the needs of the battery and only charges the current that is really needed into the battery.

The technology is enclosed in a robust industry-standard housing. The compact design meets all requirements for safety standards, reduces space requirements, and protects the components for a long service life.

Featuring a graphic display, an integrated datalogger, new interfaces, and additional options, the device is perfectly equipped for the future.

---

## Battery configuration

### **WARNING!**

**Danger due to unsuitable batteries being connected to the charger.**

Escaping gas, fire or explosion may result in serious injury and damage to property.

- ▶ Never connect a battery to the charger unless it is compatible in terms of its type, voltage and capacity and corresponds to the charger settings.
-

---

## Mains connection

### **WARNING!**

#### **Danger from electrical current.**

This may result in serious injuries or death.

- ▶ Before starting work, switch off all devices and components involved, and disconnect them from the grid.
  - ▶ Secure all devices and components involved so they cannot be switched back on.
  - ▶ If necessary, only use a type B residual current circuit breaker for the grid connection of the device.
- 

### **WARNING!**

#### **Danger from incorrect operation and work that is not carried out properly.**

This can result in severe personal injury and damage to property.

- ▶ All the work and functions described in this document must only be carried out by trained and qualified personnel.
  - ▶ Read and understand this document.
  - ▶ Read and understand all the Operating Instructions for the system components, especially the safety rules.
- 

### **WARNING!**

#### **Danger due to faulty or insufficient grid power supply.**

This can result in severe personal injury and damage to property.

- ▶ The requirements for the grid power supply according to the "Technical data" chapter must be fulfilled.
- 

---

## Charging lead

### **WARNING!**

#### **Danger from flying sparks due to improper disconnection of the charging plug.**

This can result in severe personal injury and damage to property. The resulting sparks can ignite the charging gases that form during charging and cause a fire or explosion

- ▶ End the charging process via the battery charger and, after the charging cables have cooled down, wind them up or, if available, place them on the cable holder.
- 

---

## Warning notices on the device

A number of safety symbols can be seen on the charger's rating plate. The safety symbols must not be removed or painted over.

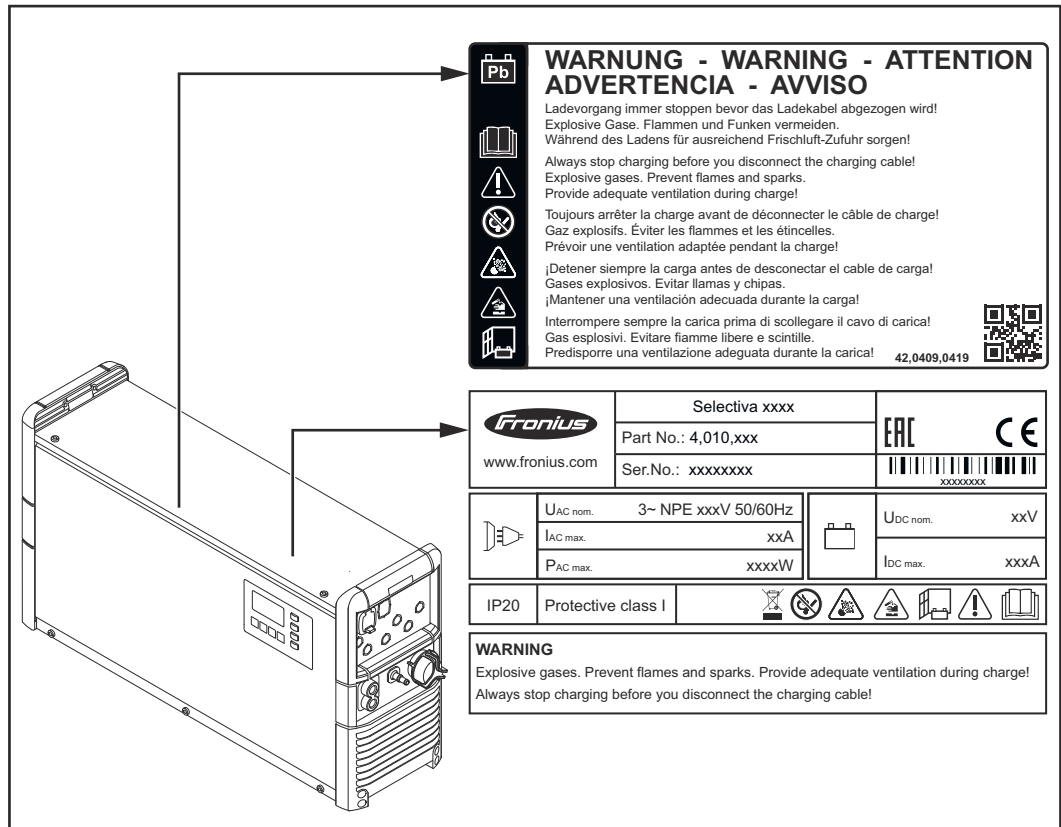

An electric shock can be fatal. The housing must never be opened by anyone other than a service technician trained by the manufacturer. The device must be disconnected from the mains before starting any work with the housing open. A suitable measuring instrument must be used to ensure that electrically charged components (e.g. capacitors) are fully discharged. Ensure that the device remains disconnected from the mains until all work has been completed.



Do not use the functions until you have fully read the Operating Instructions.



Possible sources of ignition, such as fire, sparks and naked flames, must be kept away from the battery.



Risk of explosion! Oxyhydrogen is generated in the battery during charging.



Battery acid is corrosive and must be kept away from eyes, skin and clothes.



Ensure an adequate supply of fresh air during charging.



The charger can cause DC fault currents in the ground conductor. If a fault current protection device (RCD) is used on the mains side to protect against electric shock, it must conform to type B.



Do not dispose of the product in domestic waste. Dispose of it according to the disposal requirements for waste electrical and electronic equipment valid at the installation site.

**Warning notices  
inside the device**

**⚠ WARNING!**

**Danger from electric current.**

This can result in serious injury or death.

- ▶ The housing must never be opened by anyone other than a service technician trained by the manufacturer.
- ▶ Before starting work, switch off all the devices and components involved and disconnect them from the grid.
- ▶ Secure all the devices and components involved to prevent unintentional re-starting.
- ▶ After opening the device, use a suitable measuring instrument to check that electrically charged components (such as capacitors) have been discharged.
- ▶ Use an easily legible and understandable warning sign to ensure that the device is not reconnected to the grid before all the work has been completed.

	RCS 3.0	Lights
(1)	1	12V
(2)	2	GREEN
(3)	3	YELLOW
(4)	4	RED
(5)		BLUE
(+)		Temp. Sensor
(-)		Ext. Start/Stop

**⚠ WARNING Hazardous Voltage**

Kondensator Entladezeit < 2 min.  
 Capacitor discharge time < 2 min.  
 Décharge de condensateur < 2 min.  
 Condensador tiempo de descarga < 2 min.  
 Condensatore tempo di scaricamento < 2 min.

**WARNING!**

**Risk of Electric Shock!**  
 Do not operate at circuits more than 250V to ground!

0... 30V DC/4A 0... 250V AC/4A	<b>C</b> Common <b>NC</b> Normally Closed <b>NO</b> Normally Opened <b>L</b> Line <b>N</b> Neutral Wire
-----------------------------------	---

**Use Copper Conductors Only!**

C NC NO

1

C NC NO

2

C NC NO

3

max. 1A AC Output!

L/C NC/NO/N

4

42100010018

## Setup regulations

### **WARNING!**

#### **Danger from devices falling or toppling over.**

May result in serious injuries or death.

- ▶ Set up all system components in a stable position. When using a floor bracket or wall bracket, always ensure that all fastening elements are firmly seated.
- ▶ Devices weighing more than 25 kg (55.12 lb.) must be carried by at least 2 persons.
- ▶ When mounted on a shelf, the load capacity of the shelf must at least correspond to the weight of the device.

The device has been tested according to degree of protection IP20. This means:

- Protection against the penetration of solid foreign bodies with a diameter of more than 12.5 mm (0.49 in.)
- No protection against water.

The device can be set up and operated in dry, closed rooms in accordance with degree of protection IP20. Avoid exposure to moisture.

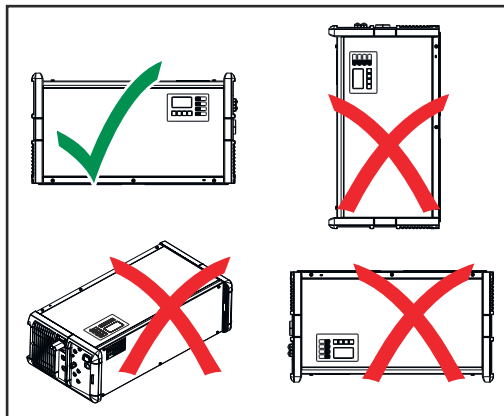

The permissible operating position of the device is horizontal.

The ambient air surrounding the device must be kept free from battery acid vapors. Mounting the device directly above the battery to be charged should therefore be avoided.

#### **Cooling air**

The device must be set up so that cooling air can flow through the housing openings provided unhindered. There must always be a minimum distance of 0.2 m (7.874 in.) from the air inlet and outlet openings. The ambient air must be free from

- excessive dust exposure,
- electrically conductive particles (carbon black or metal chips),
- heat sources.

The cooling air flows in and out as indicated by the arrows in the following illustrations.

### **NOTE!**

**Air inlet and outlet openings must not be blocked or even partially covered.**

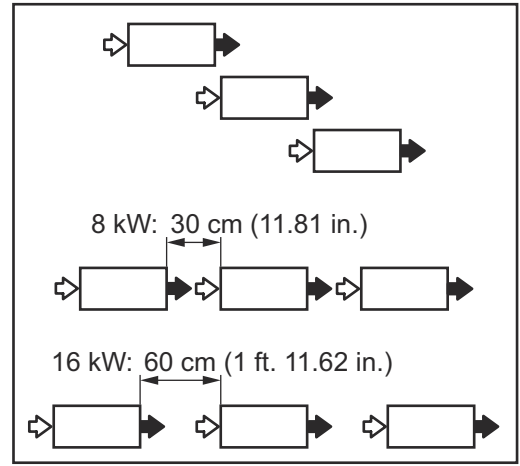
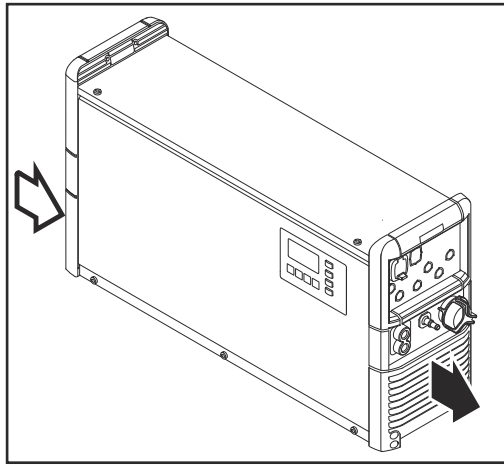

The setup of several devices one behind the other should be staggered.

The setup of several devices one behind the other should be staggered, otherwise a minimum distance of:

- 8 kW: Minimum distance 30 cm (11.81 in.)
- 16 kW: Minimum distance 60 cm (1 ft. 23.62 in.)

must be observed.

## Wall bracket

### **WARNING!**

#### **Danger due to incorrect operation and incorrectly performed work.**

This may result in serious injury and damage to property.

- ▶ All the work and functions described in this document must only be carried out by trained and qualified personnel.
- ▶ Read and understand this document.
- ▶ Read and understand all the Operating Instructions for the system components, especially the safety rules.
- ▶ Different wall plugs and screws are required depending on the supporting surface. Wall plugs and screws are therefore not included in the scope of supply. The installer is responsible for selecting the correct wall plugs and screws.

### **WARNING!**

#### **Danger from machines falling or toppling over.**

This may result in serious injury and damage to property.

- ▶ Ensure that all screw connections are secure.
- ▶ Only use with a Fronius Selectiva 8/16 kW charger.
- ▶ Ensure the device is level when mounting.

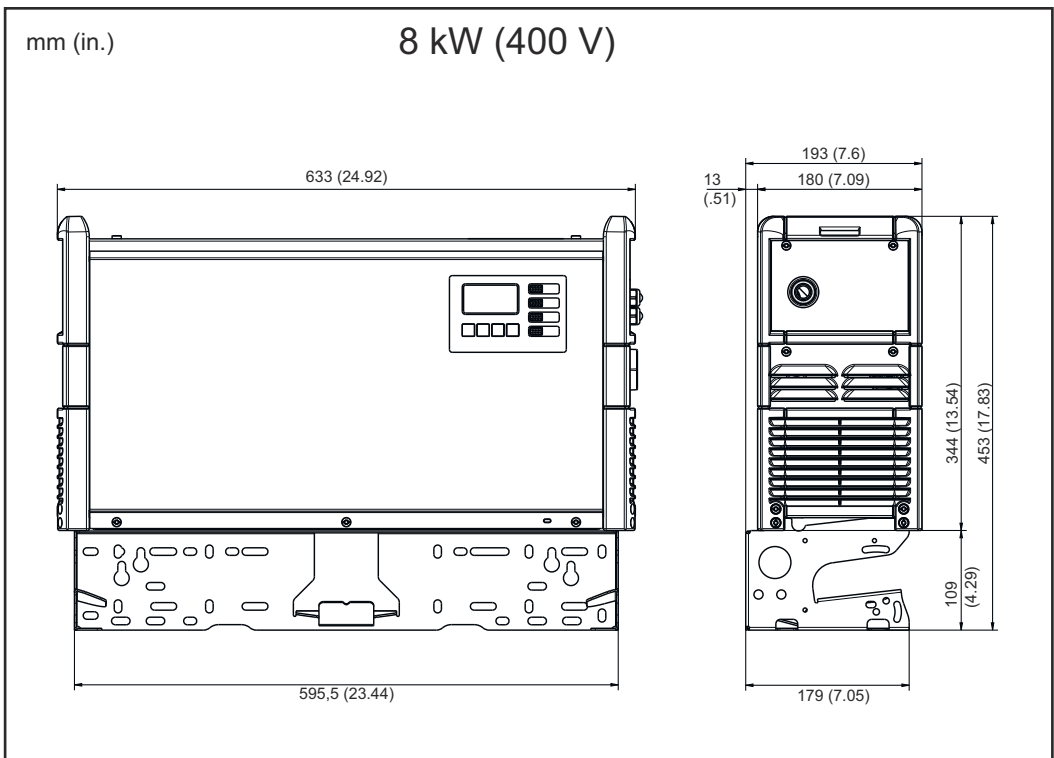
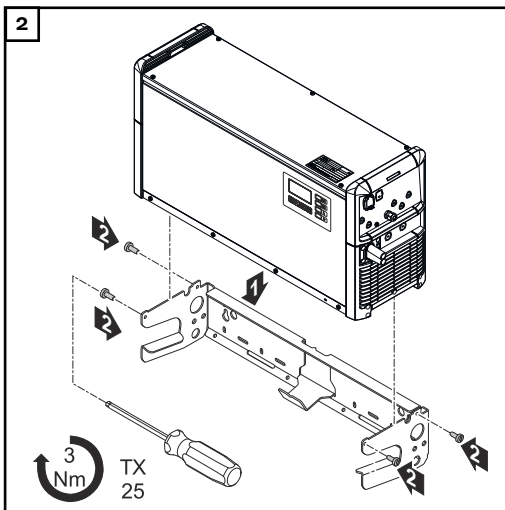
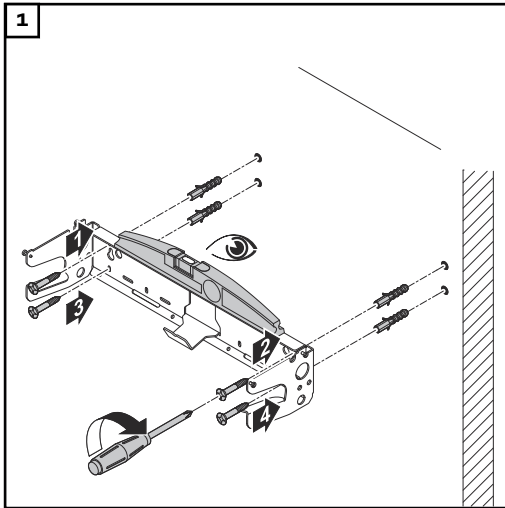



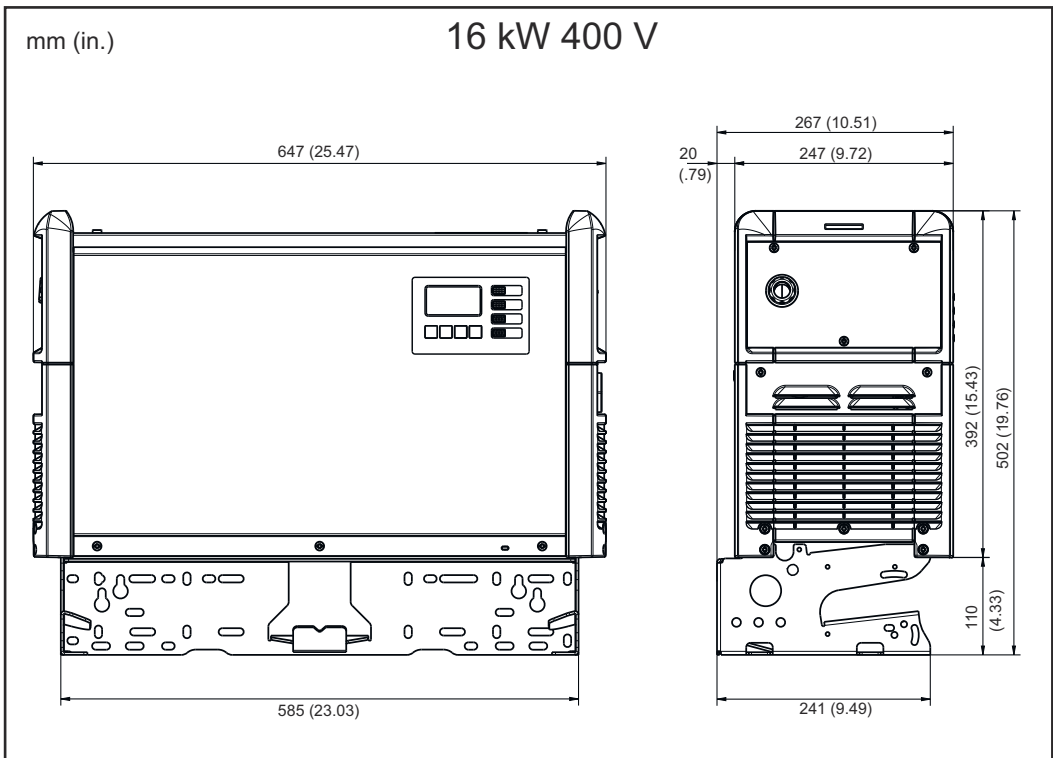
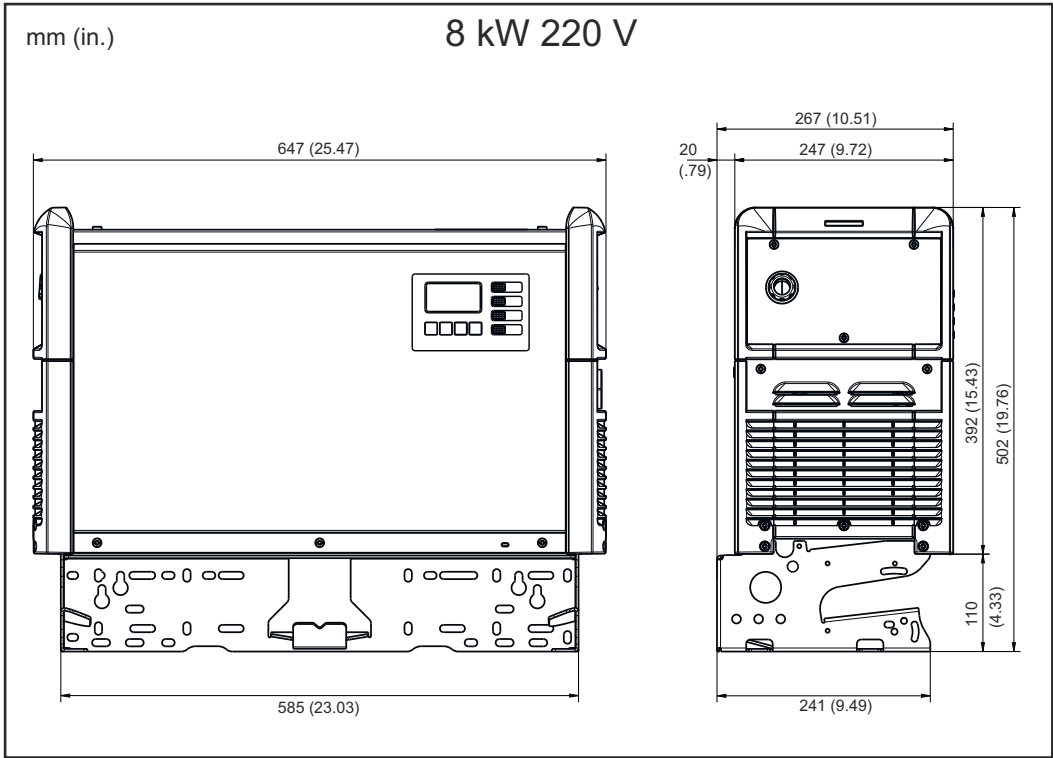

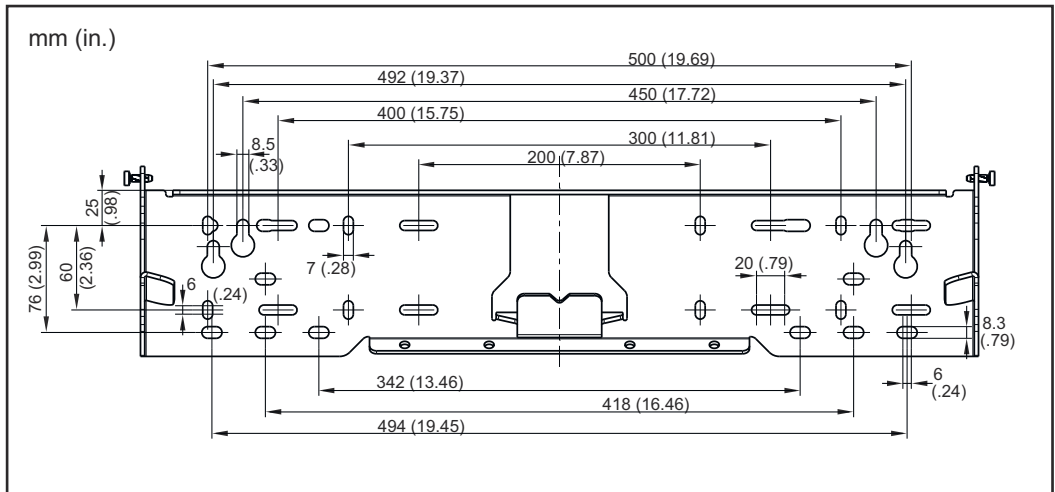

*Drilling template*

**Weight of wall bracket:**

- 8 kW 400 V: 1.8 kg (3.97 lb.)
- 8 kW 220 V: 3.15 kg (6.49 lb.)
- 16 kW 400 V: 3.15 kg (6.49 lb.)

**Correct installation of the mains/charging cables**

**⚠ WARNING!**

**Danger due to charging cables lying around.**

This can result in severe personal injury and damage to property. Personnel can get caught or trip on unplugged, loose cables.

- ▶ Lay charging cables so that no one can trip over them or get caught on them.

**⚠ CAUTION!**

**Danger due to overheating as a result of incorrectly laid mains/charging cables.**

Risk of damage to the mains/charging cables.

- ▶ The mains/charging cable may only be replaced by a qualified electrician.
- ▶ Lay the mains/charging cable without a loop.
- ▶ Do not cover the mains/charging cable.
- ▶ Charging cables longer than 5 m (16 ft. 4.85 in.) must be laid individually (no bundling).
- ▶ Charging cables longer than 5 m (16 ft. 4.85 in.) can have an increased surface temperature (be aware of hot surfaces).
- ▶ In the following cases, pay special attention that the surface temperature of the charging cables does not exceed 80°C (176°F):
  - Ambient temperature is 30°C (86°F) or more
  - Cross-section of the charging cable is 95 mm<sup>2</sup> or more
  - Length of the charging cable is 5 m (16 ft. 4.85 in.) or more

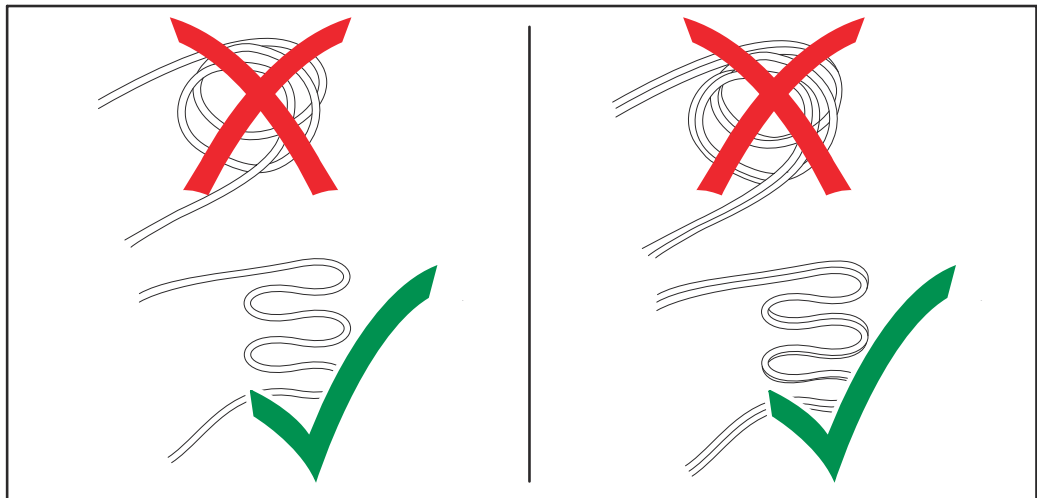

# Control elements and connections

## Controls and connections

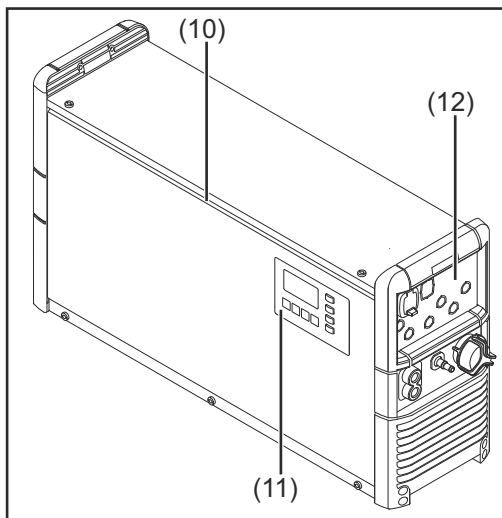
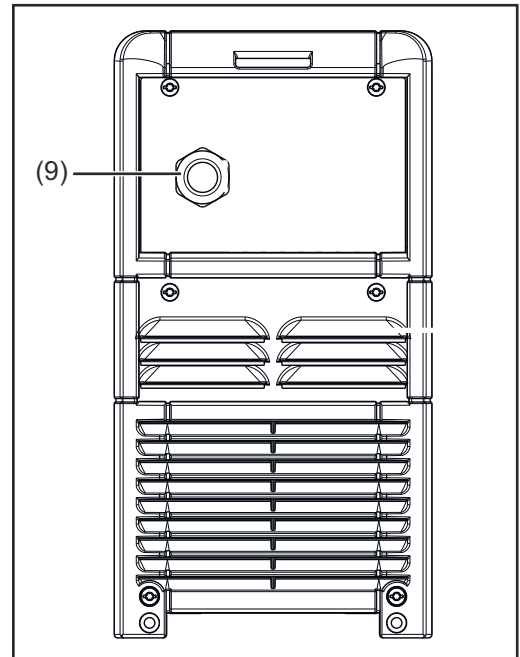
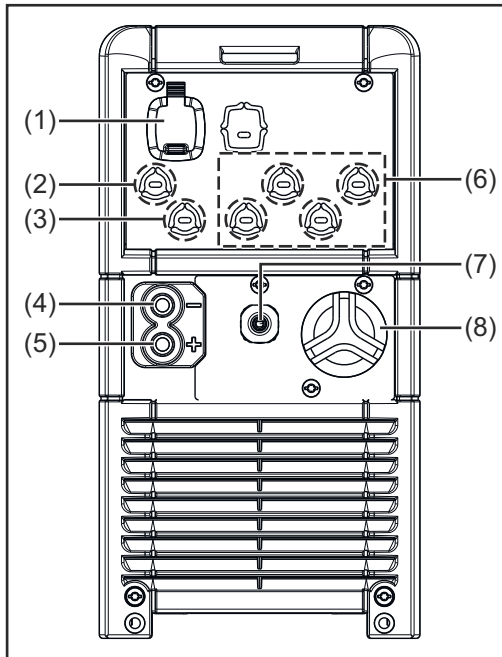

No.	Function
(1)	<b>USB port</b> The USB port allows a USB flash drive to be used to update the device and also to log the charging parameters while charging is in progress. The maximum supply current is 0.5 A.
(2)	<b>Position for the remote control system or charging lights options.</b>
(3)	<b>Position for the external start/stop option or temperature-controlled charging option.</b>

No.	Function
(4)	<b>(-) Charging lead</b>
(5)	<b>(+) Charging lead</b>
(6)	<b>Positions for the relay-related options.</b> (e.g. Aquamatic control) More information can be found in the "Options" chapter.
(7)	<b>Position for the internal electrolyte circulation option.</b> Compressed air outlet
(8)	<b>Position for the internal electrolyte circulation option.</b> Air intake with air filter

---

**(9) Mains cable**

---

**(10) Optional LED strip.**

Lights up in different colours depending on the state of charge, as explained in the "Control panel" section.

---

**(11) Control panel**

---

**(12) CAN connection area**

The connection area can only be accessed by removing the connection plate on the front of the device.

The warning notices in the "Safety" section of the "Options" chapter must be obeyed.

---

## Control panel

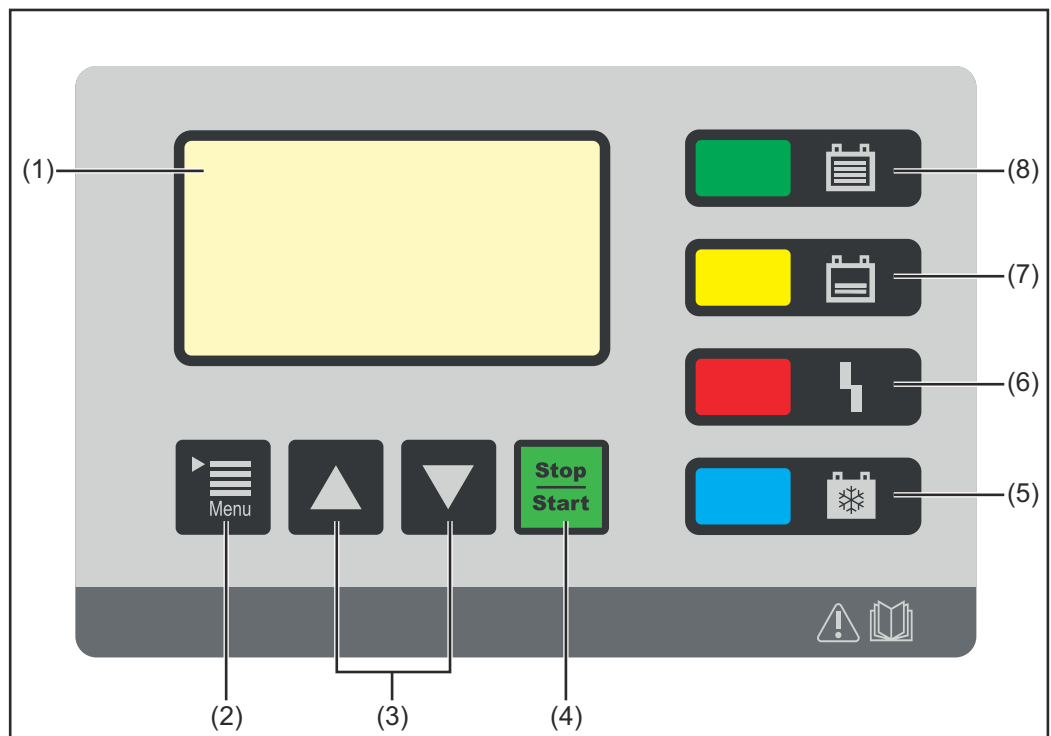

---

No.	Function
-----	----------

---

**(1) Display**

Displays the current charging parameters  
Displays settings

---

**(2) "Menu" key**

Selects the desired menu  
Selects the appropriate symbol to return to the previous display

---

**(3) "Up/Down" keys**

Selects the desired menu item  
Sets the desired value

---

**(4) "Stop/Start" key**

For interrupting and resuming the charging process  
Confirms a menu item or setting

---

---

(5) **"Battery cooled down" indicator (blue)**

Indicates that a battery has cooled down and is ready for use

**On steady:** After charging has finished, the set cooling time or optionally the battery temperature has been reached.

**Flashes every second:** The water refill indicator has also tripped.

More information can be found under "Additional functions" in the "Display" section.

---

(6) **"Fault" indicator (red)**

**On steady:** The charger outputs an error. The current conditions do not allow proper charge. While the red indicator is on, charging cannot take place (charging interrupted). The relevant status code appears in the display.

**Flashes briefly every 3 seconds:** The charger outputs a warning. Charging is continued despite the adverse charging parameters. The relevant status code and the state of charge appear alternately on the display.

---

(7) **"Charge" indicator (orange)**

**Lit:** during charging

**Flashes:** If charging has been interrupted

---

(8) **"Battery charged" indicator (green)**

**On steady:** Charging ended

**Flashes every second:** Charging ended. The water refill indicator has also tripped.

---

# Charging the battery

## Charging

### **WARNING!**

#### **Danger due to escaping battery acid or explosion if faulty batteries are charged.**

This may result in serious injury and damage to property.

- ▶ Before charging, ensure that the battery to be charged is fully functional.

### **WARNING!**

#### **Danger due to faulty charging settings or a defective battery.**

This may result in serious injury and damage to property.

- ▶ Before charging, ensure that the battery to be charged is fully functional.

### **NOTE!**

#### **Risk of property damage if the charging plug contacts are very dirty.**

The resulting increase in contact resistance can lead to overheating and subsequent destruction of the charging plug.

- ▶ Keep the charging plug contacts free from impurities and clean them if necessary

- 1 Connect the charger mains plug to the electrical mains supply

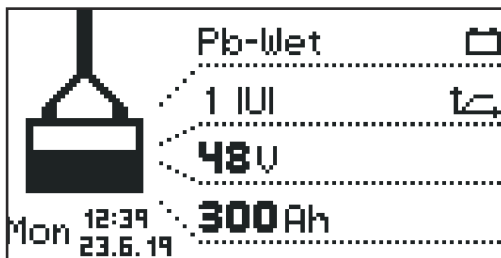

The display appears in standard mode. The display shows the charger parameters:

- Type of battery (e.g. wet)
- Charging characteristic (e.g. IUI)
- Nominal voltage (e.g. 48 V)
- Capacity (e.g. 300 Ah)
- Day of the week, date and time

The charger parameters can be set individually. More information on the charger parameters can be found under "Configuration mode" in the "Display functions" chapter. Ensure that the battery to be charged matches the configuration of the battery charging system.

- 2 Connect the charging plug or connect the  
(+) charging lead to the positive pole of the battery and the  
(-) charging lead to the negative pole of the battery

The charger detects that the battery is connected and starts charging. If start-up delay is activated, then charging will start at the end of the set delay time. For more information, see "Configuration mode" in the "Display" section.

During the charging process the display shows the following values:

- Current charging current (A)
- Current charging voltage (V)
- The charge already input (Ah)
- Battery temperature with the "temperature-controlled charging" option
- The time (hh:mm) since charging started

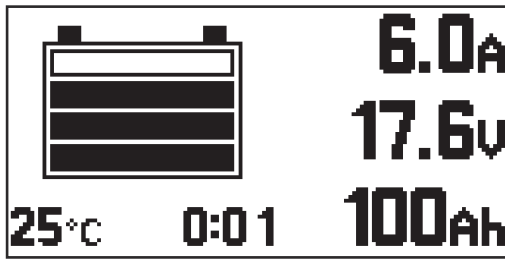

The battery symbol indicates the current state of charge. The greater the number of bars that are displayed, the further advanced the charging process is. As soon as the battery is fully charged, a minute counter will appear (see figure on right). This counts the minutes since the end of charging; when a number of chargers are being used, this makes it easier to decide which battery will have already cooled down most.

If, however, the standard display is still to be shown rather than the minute counter:



1 Use the "Up/Down" keys to toggle between the minute counter and standard display

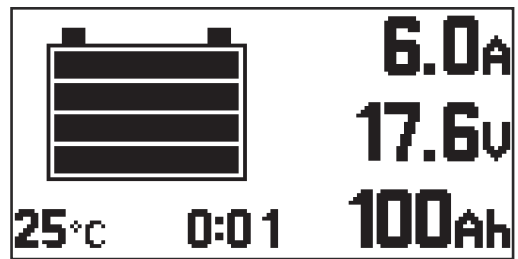

When the battery is fully charged all 4 bars of the battery symbol appear black. As soon as the battery is fully charged, the charger begins conservation charging.

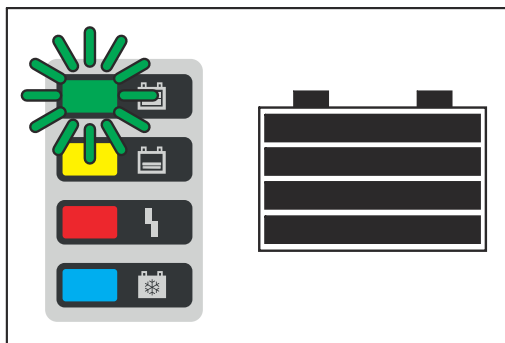

- All bars are displayed
- The green "Battery charged" indicator is on
- The battery is always ready to use
- The battery can remain connected to the charger for as long as required
- Conservation charging counteracts battery self discharge

### Interrupting charging

To interrupt the charging process:



1 Press the "Stop/Start" key

While the charging progress is interrupted:



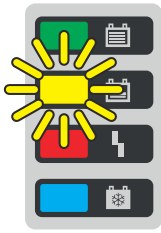

The "Charge" indicator (yellow) flashes

To resume the charging process:



2 Press the "Stop/Start" key again

As long as a battery is connected to the charger, only the charging process can be interrupted and resumed using the "Stop/Start" key. Display modes can be changed using the "Menu" key as described in the "Display" section, but this is only possible when there is no battery connected to the charger.

## Stopping charging

### **WARNING!**

**Danger due to ignition of oxyhydrogen caused by sparks generated when the charging cables are disconnected.**

This can result in serious injury and damage to property.

- ▶ Before disconnecting or unplugging the charging plug, first stop the charging process by pressing the "Stop/Start" key

### **NOTE!**

**Risk of damage to the battery if it is disconnected from the battery charger before the charging process is complete.**

This may result in damage to the battery.

- ▶ Only disconnect the battery from the charger when it is fully charged (green "Battery charged" indicator lights up)

As soon as the battery is fully charged and has cooled down, the following indicators light up:

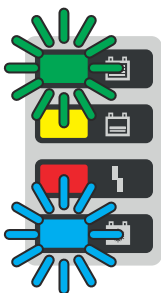

- "Battery charged" indicator (green)
- "Battery cooled down" indicator (blue)

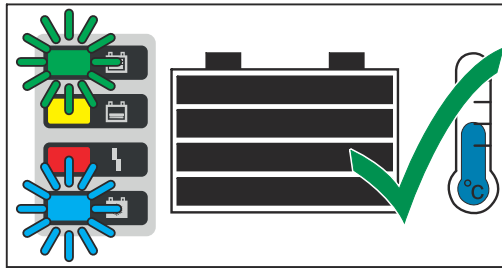

For an optimal battery life, only disconnect the battery from the battery charger when the blue "Battery cooled down" indicator is showing in addition to the green indicator, in accordance with the explanation below. If several battery chargers are in use, first disconnect the battery which has been fully charged for the longest (the coolest).

To stop the charging process:







**1** Press the "Stop/Start" key

- 2** Unplug the charging plug or disconnect the  
(-) charging lead from the negative pole of the battery and the  
(+) charging lead from the positive pole of the battery

When the charging contacts are open, the automatic open circuit voltage detection ensures that the charging contacts are de-energised.

# Display

## Overview of display modes

No.	Function
	<b>Standard mode</b> In standard mode the display shows the charging parameters.
	<b>Statistics mode</b> Visualises the frequency of the device operating modes and shows the total number of charging actions. Also shows an overview of the total and average Ah produced and energy consumed per charge.
	<b>History mode</b> Provides information about the parameters for all the stored charging processes.
	<b>Configuration mode</b> Configuration mode enables all the settings for the device and the charging process to be adjusted.
	<b>USB mode</b> USB mode enables a device to be updated, device configurations to be saved and loaded, and the charging parameters to be recorded during the charging process - all using a USB flash drive.

As long as a battery is connected to the battery charger, the charging process can only be interrupted and resumed by pressing the "Pause/Start" button. It is only possible to change the display modes with the "Menu" button after disconnecting the battery from the battery charger. A detailed description of the display modes is given in the following chapter.

A limited menu selection is available while charging has been paused.

### NOTE!

**A limited menu selection is available while charging has been paused.**

## Standard mode

Once the mains plug has been connected to the electrical mains supply, the display will automatically operate in standard mode.

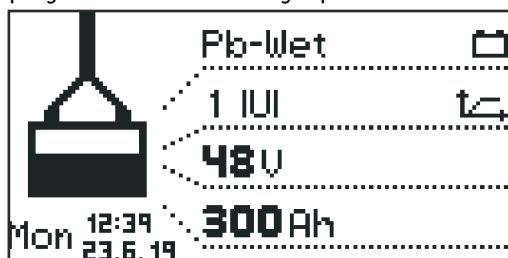

In standard mode, the display shows the following charger parameters:

- Type of battery (e.g. Pb-WET)
- Charging characteristic (e.g. IUI)
- Nominal voltage (e.g. 48 V)
- Capacity (e.g. 300 Ah)
- Day of the week, date and time

The charger parameters can be set individually. More information can be found in the "Configuration mode" section.

## Menu selection

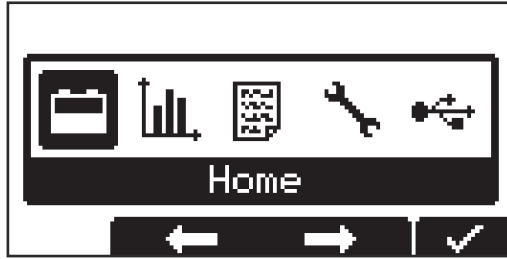

Change from standard mode to the menu selection as follows:

- 1 Press and hold the "Menu" key for approx. 5 seconds.

Change from all other modes to the menu selection as follows:

- 1 Briefly press the "Menu" key.

To select the desired mode:

- 2 Use the "Up/Down" keys to select the symbol for the desired mode.
  - e.g. the battery symbol for standard mode
- 3 Use the "Pause/Start" key to confirm the "Tick" symbol.

## Statistics mode



In statistics mode, horizontal bars display the frequency of the following device operating statuses:

- Idle
- Charging
- Floatingcharge
- Cooldown
- Error

- 1 Use the "Up/Down" keys to toggle between page 1/2 and page 2/2.

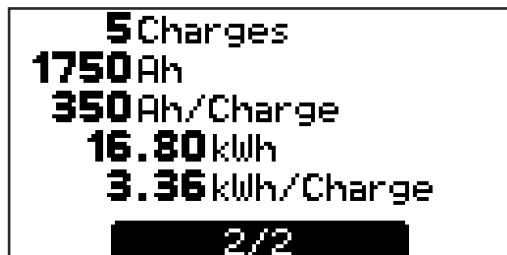

Page 2/2 shows the following values:

- Total number of charges.
- Total Ah output.
- Average Ah output per charge.
- Total energy consumed (kWh).
- Average energy consumed (kWh) per charge.

The consumed energy display is a standard value and can deviate from the actual amount of energy by up to 5% at nominal output. At lower power levels the deviation may be higher.

## History mode

History mode provides information about the parameters for all the stored charging processes. In order to show changing or different displays, two versions of the display window are shown below:

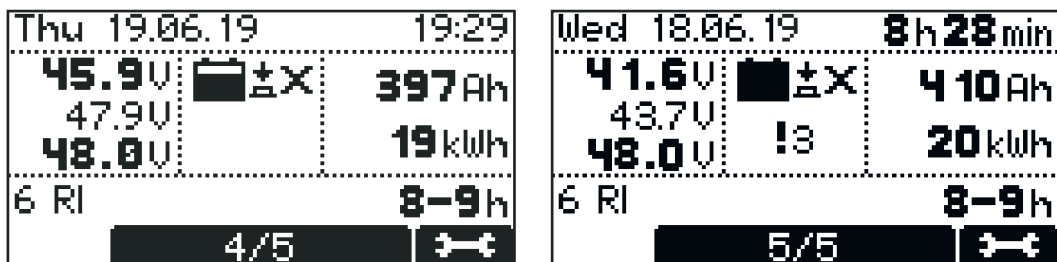

- 1 Use the "Up/Down" keys to switch between the pages for each stored charging process.

#### Contents of the display window

- Charge start date, e.g.: Thursday, 19/06/14.
- Charge start time, e.g.: 19:29 or charging time, e.g.: 8 h 28 min.
- Voltage at charge start, e.g.: 45.9 V.
- Voltage after 5 minutes, e.g.: 47.9 V.
- Voltage at charge end, e.g.: 48.0 V.
- Ah consumed, e.g.: 397 Ah.
- kWh consumed, e.g.: 19 kWh.
- Charging characteristic, e.g.: 6 RI.
- Set charging time, e.g.: 8 - 9 h or set Ah, e.g.: 400 Ah or set charge end time (not shown).

#### Symbols shown

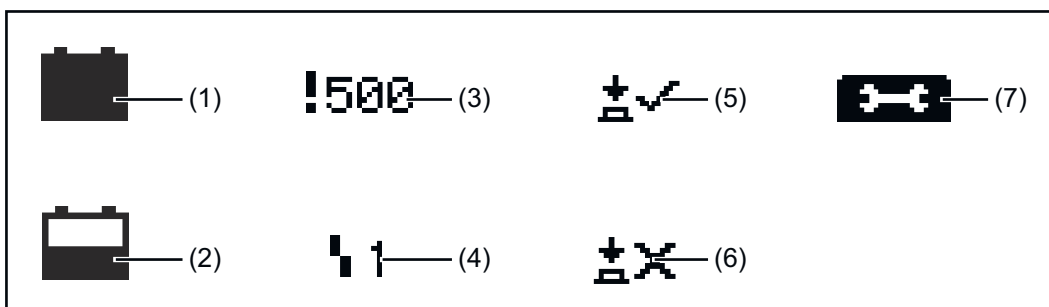

No.	Function
(1)	<b>Full battery</b> Charging has been completed.
(2)	<b>Empty battery</b> Charging has not been completed.
(3)	<b>Exclamation mark with number</b> Warning issued, with code for the corresponding status code. Detailed information can be found in the <a href="#">Status codes</a> section.
(4)	<b>Symbol with number</b> Error issued, with code for the corresponding status code. Detailed information can be found in the <a href="#">Status codes</a> section.
(5)	<b>Key symbol with a tick</b> Charging was stopped properly using the "Pause/Start" key.

---

**(6) Key symbol with a cross**

Charging was stopped without using the "Pause/Start" key.

---

**(7) Charging details**

Displays certain battery data at the beginning and end of the charging process:

Number of cells

Ah

Characteristic

Type of battery

---

---

**Configuration mode**

Configuration mode provides the following setting options:

**"Charging settings": settings for the battery**

- Type of battery, e.g. "Wet".
- Charging characteristic, e.g. "IU".
- Capacity (Ah) or charging time (h) depending on the charging characteristic.
- Cells: voltage (V) and number of battery cells or automatic setting of the number of cells.

 **CAUTION!**

**Danger of damage to the battery.**

This may result in damage to the battery.

- ▶ The number of cells should only be set automatically for batteries with the following nominal voltages: 12 V and 24 V for 24 V devices, 24 V and 48 V for 48 V devices.
- ▶ Do not set the number of cells automatically for deep discharged batteries.

- 
- Additional settings:  
for individual adaptation options for the charging characteristic.

**"Additional functions": Additional functions**

- Blue LED
- External start/stop
- Refill indicator
- Options area
- Start charging again after a grid failure

**"General options": General settings**

- Language
- Contrast
- Time (hh:mm:ss)  
Time zone  
Daylight saving time/normal time
- Date (dd:mm:yy)
- Length of charging cable (m)
- Charging cable cross section (mm<sup>2</sup>)
- AC current limitation
- Unit for temperature values
- Code for accessing the configuration menu activated/deactivated.
- Time interval for the parameters recorded on the USB flash drive (s).
- Reset statistics
- Reset history

### "Reset Settings"

- Includes a double-check prompt ("OK?") that requires the operator to reconfirm that this step is intended.

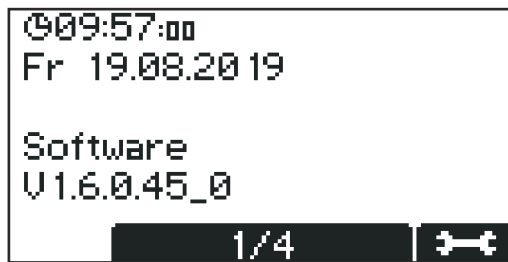

First the screen will appear in its initial format, showing the date, time and software version.

- 1 The "Up/Down" keys can be used to retrieve the following information:
  - Serial number of the charger plus serial number and version of the configuration memory.
  - PC board for controller/power electronics: hardware version and serial number.
  - Software: main software, secondary software, primary software and characteristic block version.

The procedure for opening the configuration menu is as follows:

- 1 Press the "Pause/Start" key.



You will be prompted to enter a code.



The code required is "1511" and is entered as follows:

- 1 Using the "Up/Down" keys, enter the first digit of the code.
- 2 Press the "Menu" key to move to the next digit of the code.
- 3 Continue following the procedure described above until the complete code has been entered.
- 4 Use the "Pause/Start" key to confirm the code entered.

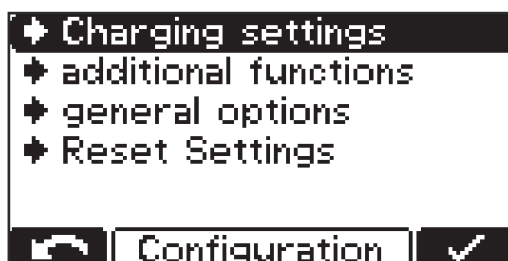

You will now be prompted to select one of the main menu items for the configuration mode.

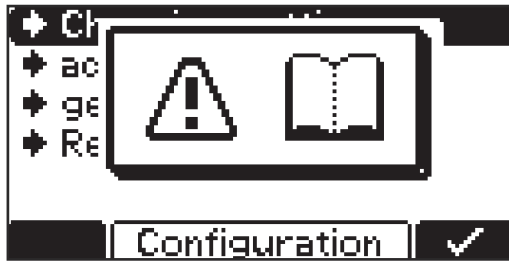

When you select a menu item you may be presented with a prompt to read the Operating Instructions. Confirm this prompt by pressing the "Pause/Start" key again.

The procedure for navigating the configuration menu and its submenus is as follows:

- 1 Use the "Up/Down" keys to select the desired menu item.
- 2 Use the "Pause/Start" key to confirm the menu item, and reconfirm any double-check prompt (e.g. "OK?").
- 3 Use the "Up/Down" keys as necessary to choose an item, e.g. "Off/On" or enter a value.
- 4 Use the "Pause/Start" key to confirm what you have entered.
- 5 If the cursor moves to another setting or position after confirmation of the previous setting, repeat the procedure described in points (3) and (4).

To exit the current menu:

- 6 Press the "Menu" key to return to the higher-level menu.

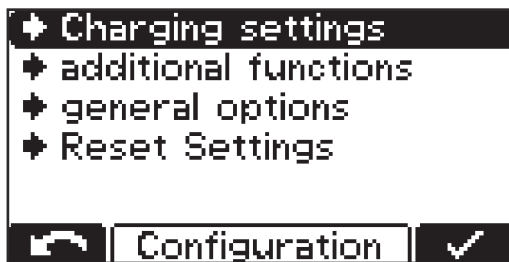

See the following explanation of how to set the charging settings by way of example:

- 1 Use the "Up/Down" keys to select the "Charging settings" menu item.
- 2 Use the "Pause/Start" key to confirm this menu item.

The choice of settings for the "Charging settings" menu item will now be displayed:

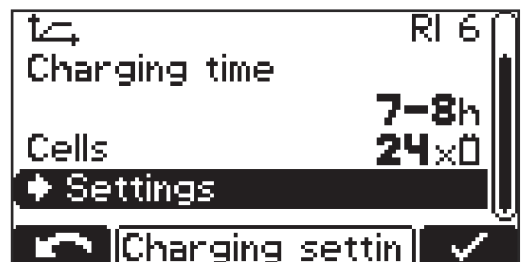
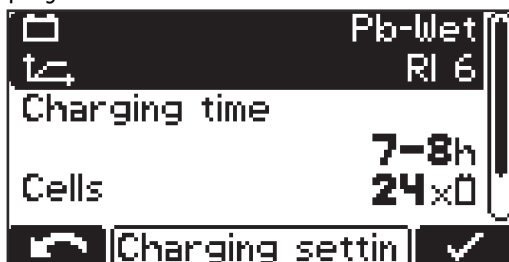

the display may vary depending on the selection made. If the "Pb-WET" type of battery has been selected in combination with the "RI" characteristic ("Curve") as in the example here, the "Ah" heading is replaced by the "Charging time" setting option.

Both the start and end time can be set for this charging time period. The starting time can be deselected as required; the charging time then bases itself exclusively on the specified charge end time following a manual charge start.

When applying the settings, the user will be guided through the menu in much the same way as a wizard function.



- 3 Use the "Up/Down" keys to select the desired parameter (e.g. "Cells").
- 4 Use the "Pause/Start" key to confirm the parameter.
- 5 Use the "Up/Down" keys to set the desired value (e.g. "24" for the number of battery cells).
- 6 Use the "Pause/Start" key to confirm what you have entered.

If one or more relevant settings are changed for the charging process in configuration mode, you will once again be prompted to confirm acceptance of the changed settings when exiting configuration mode.

The following settings need to be confirmed when exiting configuration mode:

- Characteristic
- Battery capacity in Ah (excluding the RI characteristic)
- Number of cells
- Equalising charge ON/OFF
- CAN protocol

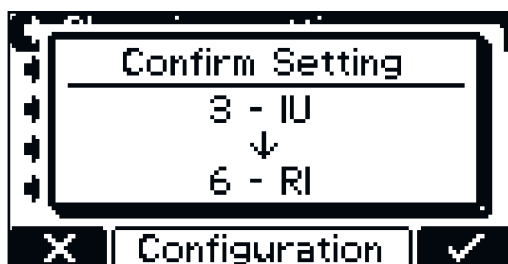

**Example:**

Changing the characteristic from 3 - UI (Pb-WET) to 6 - RI (Pb-WET).

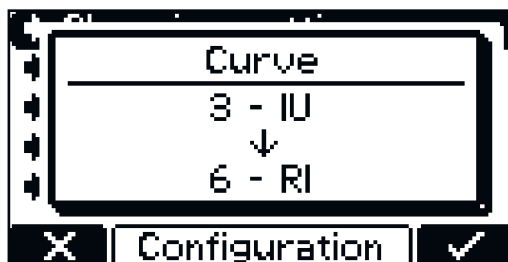

If the setting is not confirmed, the charger returns to configuration mode and the setting can be changed to the desired value.

**Overview of charging settings**

Below is a detailed explanation of the "Settings" menu item, selected under the aforementioned "Charging settings" menu item. Navigation is carried out as described in the [Configuration mode](#) section.

A list appears with the following selection options:

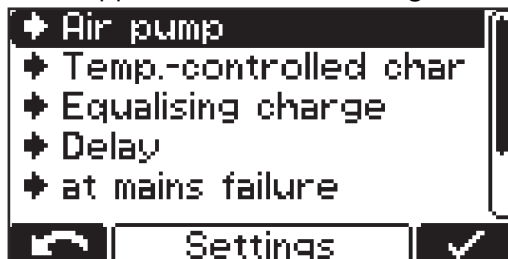

The individual selection options are explained in greater detail below.

## Electrolyte circulation

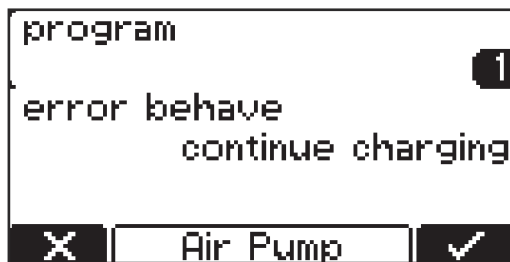

"Air Pump" electrolyte circulation (*not available on the Selectiva 220 V variant*):

The electrolyte circulation cycle is controlled by the charger's control system. A number of selection options are available for this purpose.

The following settings are available for electrolyte circulation:

### Off

- Electrolyte circulation switched off.

### Continuous operation ("continuous")

- Electrolyte circulation permanently on.

### Program 1 to 5

- Default electrolyte circulation programs and their relevant parameters can be found in the table under "Settings" in the "Display" chapter.

### Automatic

- Automatic adjustment of the electrolyte circulation flow rate based on the set battery parameters.

### User - "On"/"Off"

- Individual setting of the electrolyte circulation.
- The settings for "On" and "Off" determine the pulse/pause ratio of the air flow intervals.

Default electrolyte circulation programs and their relevant parameters can be found in the table below:

Program	ON 1	OFF 1	Repeat	ON 2	OFF 2
1	30 min	25 min	1 x	5 min	25 min
2	3 min	10 min	4 x	3 min	20 min
3	3 min	12 min	1 x	3 min	12 min
4	5 min	10 min	3 x	5 min	20 min
5	2,5 min	7,5 min	1 x	2,5 min	7,5 min

In each of these programs, the solenoid valve opens for a time "ON 1" and closes for a time "OFF 1". This process is repeated for the number of times specified under "Repeat". After this number of repetitions has been completed, the process continues with the "ON 2" and "OFF 2" times until charging is completed.

## Temperature-controlled charging

Temperature-controlled charging:

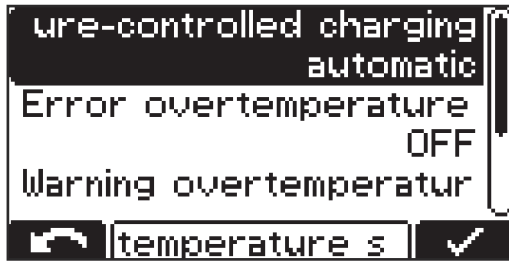

The following settings are available for temperature-controlled charging:

**automatic/OFF/required**

- automatic ... Temperature-dependent adjustment of the charging characteristic.
- OFF ... The measured battery temperature is not taken into account.
- required ... Charging only starts if the temperature sensor is connected.

**Error overtemperature ON/OFF**

- ON ... Error message in the event of battery overtemperature. Charging process stops and can only be continued once the battery has cooled down and been reconnected.
- OFF ... No error message in the event of battery overtemperature.

**Warning overtemperature ON/OFF**

- ON ... Warning in the event of battery overtemperature.
- OFF ... No warning in the event of battery overtemperature.

An external temperature sensor is required for certain characteristics. If this type of characteristic is selected in configuration mode, a note is shown indicating that an external temperature sensor is required.

**The following characteristics require an external temperature sensor:**

- 28 - FCC IUI - CSM WET
- 30 - FCC IUI - WET

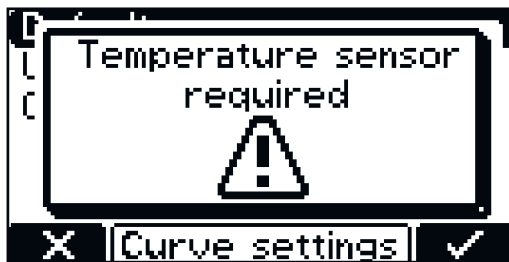

A note is displayed if a characteristic that requires an external temperature sensor is selected.

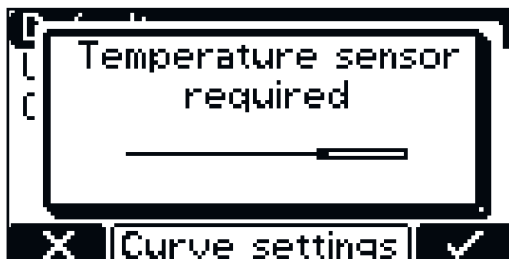

1 Use the "Pause/Start" key to confirm the note.

**Equalising charge**

**Equalising charge**

**OFF**

- There is no equalising charge.

### Delay

- If the battery remains connected to the charger for the duration of the equalising charge delay ("equalize charge delay"), a special type of charging takes place. This prevents acid stratification.
- The parameters for the current (ampere/100 ampere hours), voltage (volt/cell) and duration of the equalising charge may all be changed.

### Weekday

- Specify the weekday on which the equalising charge is to take place.
- The parameters for the current (ampere/100 ampere hours), voltage (volt/cell) and duration of the equalising charge may all be changed.

### Manual equalising charge ("Manual")

- An equalising charge can be started manually by pressing the relevant key on the display.
- The equalising charge starts after a set delay time has been observed. The charge parameters that have been set are followed.
- The parameters for the current (ampere/100 ampere hours), voltage (volt/cell) and duration of the equalising charge may all be changed.
- This function is only available for Pb-Wet characteristics.

If a setting for the equalising charge is enabled, a symbol on the home screen next to the set ampere hours or charging time shows whether an equalising charge is being carried out or can be started.

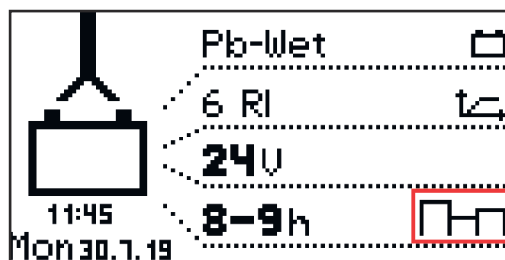

## Delay

### "Delay"

#### "Charge start delay"

- Delay time (minutes) between the activation time of the charge start and the actual charge start.

#### "Charge end delay"

- Delay time (minutes) between the signaled end of charge (e.g. green indicator) and the actual end of charge.

#### "At mains failure restart charging"

- If this option is activated, the charging process is automatically restarted after a fault in the electrical network as soon as the electrical network is available again.

#### "At mains failure"

- Restart charging
- Automatic/continue charging

If the "Restart charging" option is activated, the charging process is automatically restarted after a fault in the electrical network as soon as the electrical network is available again.

If the "Automatic/continue charging" option is activated, the charging process is automatically continued after a fault in the electrical network as soon as the electrical network is available again.

## Calendar

### Calendar

The calendar function allows charging to be started automatically according to the following criteria:

- Time window in which charging may not be started if a battery is connected.
- Time window in which charging is to be started using a defined characteristic 1 if a battery is connected.
- Time window in which charging is to be started using a defined characteristic 2 if a battery is connected.

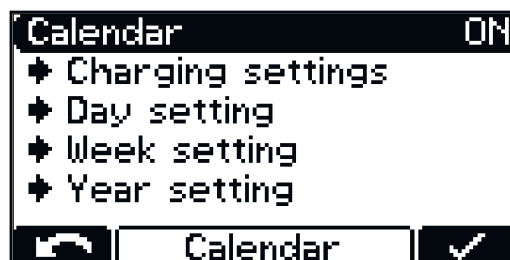

- 1 To activate the calendar function, select the "ON" setting and confirm.



"Charging settings" menu item:

- Type of battery for every characteristic: e.g. Pb-WET.
- Curve settings when selecting the relevant characteristic.

Additional settings can be found under the "Calendar" function:

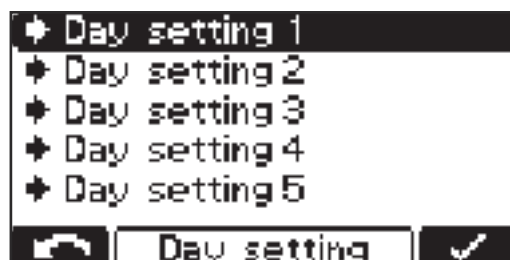

Day Setting 1-5:

The day settings allow up to five different charging start time profiles to be defined with the following settings:



- Symbol for characteristic 1: Time window in which charging is to be started using characteristic 1 (e.g.: 00:00-06:00)
- Stop: Time window in which charging must not take place (e.g.: 06:00-20:00)
- Symbol for characteristic 1: Time window in which charging is to be started using characteristic 1 (e.g.: 20:00-24:00)

**NOTE!**

**Ongoing charging operations are unaffected by the set time windows.**

- ▶ If, in the example above, a battery is connected at 05:45, the charge end time is governed according to need and is not interrupted by the end time specified for the set time window (06:00 in the example).
- ▶ If the battery is connected during the "stop" time window, charging is started automatically during the next time window. If charging is started manually during the "stop" time window, charging will always take place using characteristic 1.

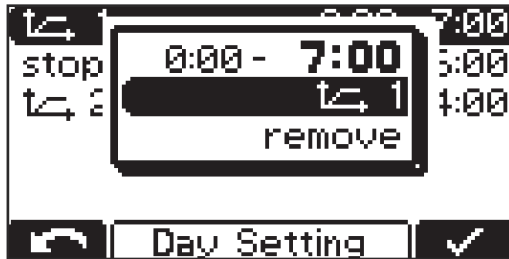

Additional settings:

- Change the allocated characteristic: characteristics symbol.
- Remove the selected characteristic: "remove".

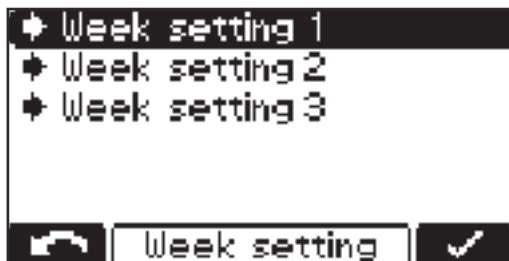

Week Setting:

- Three different week settings can be defined.

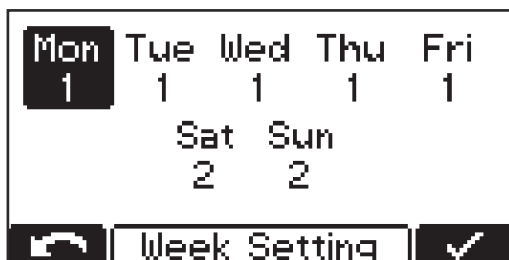

A previously created day setting can be assigned to any day of the week.

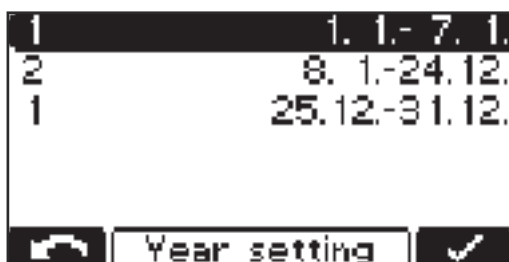

Year Setting:

- Multiple periods throughout the year may be defined, each containing a single week setting (e.g. 1/1 - 7/1).

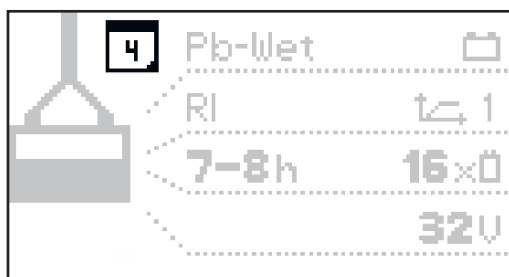

When the calendar function is active, a calendar symbol (shown here with the number "4" as the current date) appears on the display.

## Special charges

### Special Charges

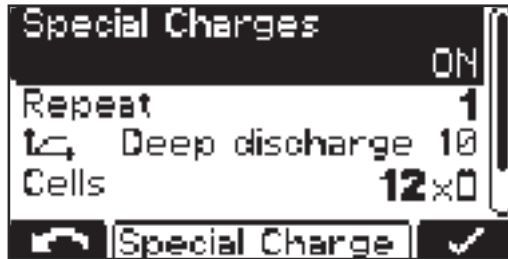

Selecting "Special Charges" allows one or more of the alternative charging types to be performed temporarily.

The "repeat" setting defines how often the alternative charging mode should be performed until the device reverts to the original charging parameters again:

#### Setting range

- 1 to 99 repetitions

#### Disable Start Button

##### ON

- The charging process cannot be started using the "Pause/Start" key, e.g. to prevent unauthorised intervention.

##### OFF

- The charging process can be started using the "Pause/Start" key.

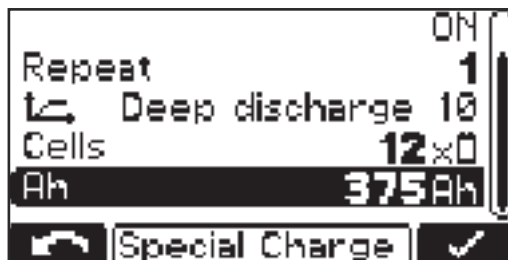

The following settings are also possible:

- Characteristic:  
e.g. "Deep discharge 10"
- Number of battery cells:  
"Cells" - e.g. 12x
- Battery capacity in Ah:  
e.g. 375 Ah

## "Opportunity Charge" special function

"Opportunity Charge" special function:



To extend the usage interval of a battery, it is possible to recharge it at a time when it will not be needed, e.g. during scheduled plant shutdowns.

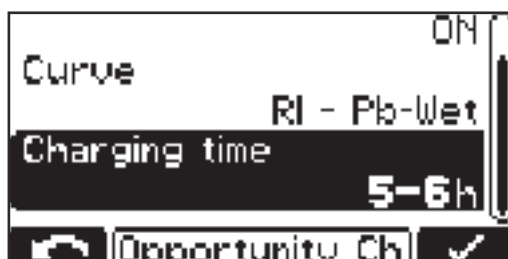

The following curve settings are available:

- Curve - e.g. RI - Pb-WET
- Charging time - e.g. 5 - 6 h

When opportunity charging is "ON" and a battery is connected, the following appears:

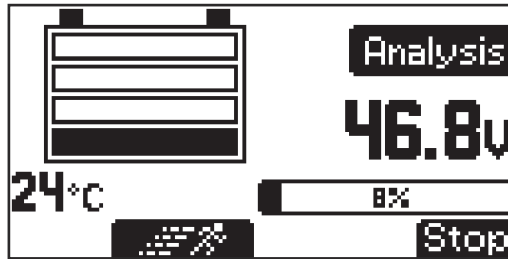

Display when RI characteristic is selected

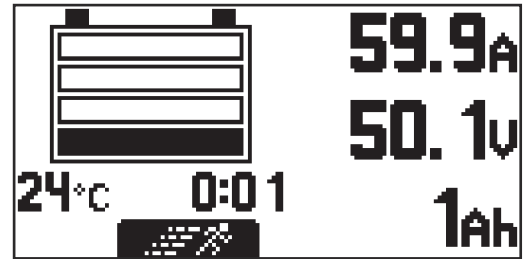

Display for other characteristics (e.g. IUI)

To start opportunity charging:

- Use the "Up" key to select the runner symbol (1).

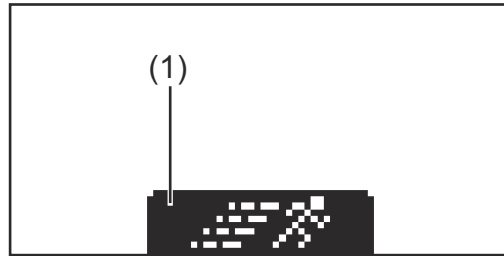

"Runner symbol" (1)



Display when opportunity charging starts

### Additional functions

Detailed explanation of the "Additional functions" menu item in configuration mode. Navigation is carried out as described in the "Configuration mode" section.

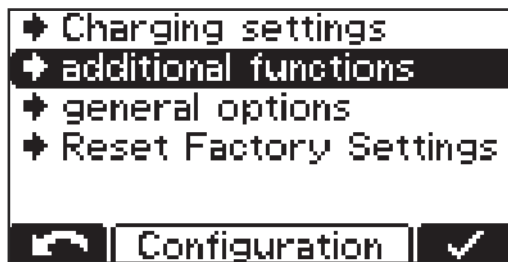

- 1 Select the "Additional functions" menu item.

A list appears with the following selection options:

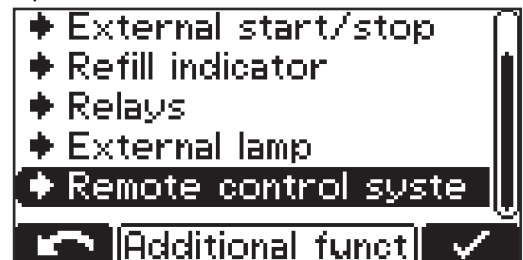
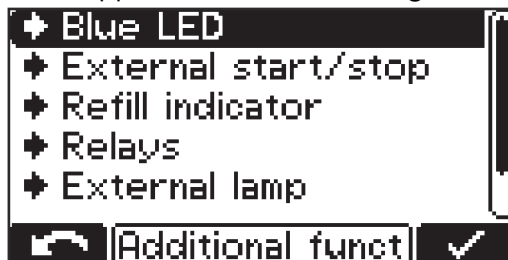

The individual selection options are explained in detail below:

#### "Blue LED"

Setting for the time (minutes) after which the blue "Battery cold" indicator should light up to indicate that the battery is sufficiently cooled down. The set value is the time from the end of charging.

In conjunction with the "Temperature-controlled charging" option, it is possible to set a temperature value from which the blue "Battery cold" indicator should light up to indicate that the battery is sufficiently cooled down.



## "External start/stop"

External start/stop	
	Normal
Start	OFF
Stop	OFF
Contact detection	ON

External start/stop ✓

The following settings are available for external start/stop:

### "Button"

- The function of the "Pause/Start" button can be simulated by means of an external button.

### Normal

- Start ON:  
Charging starts when an external switch is closed and a battery is detected or when the charging plug is connected by closing the auxiliary contacts and a battery is detected.
- Start OFF:  
Charging starts when a battery is connected.
- Stop ON:  
Charging is interrupted when an external switch is opened or when the charging plug is disconnected by opening the auxiliary contacts.
- Stop OFF:  
The opening of an external switch or the auxiliary contacts is ignored.

### "Contact detection"

- ON:  
If a battery is connected when "Start ON" is set and the external start/stop contact is not closed, the status message (16) "External start/stop is not closed" appears.  
If charging has been started when "Stop ON" is set, the external start/stop contact is opened and the battery is not fully charged, and the status message (16) "External start/stop is not closed" appears.
- OFF:  
Contact detection is not executed.

### "Refill indicator"

The refill indicator is activated as soon as it is necessary to add distilled water to the battery. The time of the refill request can be defined as follows:

#### Every x-th week and weekday

- e.g. refill water every 2nd week on Friday

When "OFF" of set, the refill request does not have to be confirmed.

## "Relays"

Relays	
➔ 1	Cumulative error
➔ 2	Charge Finish
➔ 3	Charging
➔ 4	Aquamatic

⏪ Relays ✓

Under Relays, one of the following functionalities can be set for each of the 4 terminals, viewed from left to right:

### **Aquamatic**

- Signal, e.g. for actuating a solenoid valve
- "Standard" program with settings pre-configured at the factory
- "User" program with user-defined setting options
- For more information on Aquamatic, see the "Aquamatic" section of the "Options" chapter.

### **"Charging"**

#### **"Charge 50%"**

#### **"Charge 80%"**

#### **"Charge Finish"**

#### **"Main Charge Finished"**

- Signal when main charging phase is finished

#### **"Charge not complete"**

- Signal if the battery is prematurely disconnected from the charger
- Can be set from 1 to 10 s

#### **"Charge OK"**

- Battery is being charged or is already fully charged

#### **"Cumulative Error"**

- Signal in the event of an error
- A power failure can be displayed as an error ("ON" setting).
- If the device is in an error state, a freely defined text can be displayed, which can contain the contact details of the dealer, for example. Detailed information can be found in the "USB mode" section.

#### **Cumulative error + warning**

- In the same way as the "Cumulative error" function, the corresponding relay picks up as soon as an error or warning is present.

#### **"Signal Lamp"**

- It is possible to connect one or more suitable lamps to the relay board to indicate the state of charge or the operating status of the battery charger.
- Detailed information can be found in the "Signal lamp" section of the "Options" chapter.

#### **"Immobiliser"**

#### **ON**

- The relay picks up continuously as soon as the battery charger is connected to the mains.

### "Refill Indicator"

- Indicates that it is necessary to refill the battery with distilled water.
- Detailed information can be found in the "Additional functions" section of the "Display" chapter.

### "Battery Cold"

### "External Air Pump"

- The settings are made as explained in section "-> Settings" for electrolyte circulation ("Air Pump").

Detailed information on the relay board can be found in the "Options" chapter.

### Setting for "External lamp"

According to the "Charging lights" section of the "Options" chapter, suitable external indicators can be connected in order to visualize the state of charge or the operating status of the battery charger. The following settings are available:

- Normal (conventional external indicators)
- RGB (LED strips)

### "Remote control system"



The contrast for the remote control system can be adjusted.

### "At mains failure restart charging"

If this option is activated, the charging process is automatically restarted after a fault in the electrical network as soon as the electrical network is available again.

---

## General settings

Detailed explanation of the "general options" menu item in configuration mode.

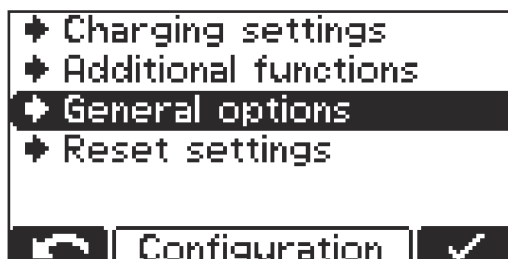

- 1 Select the "general options" menu item.

A list appears with the following selection options:

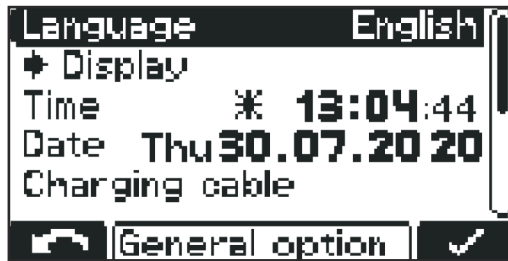

- Language
- Display settings
  - Contrast
  - LED brightness
  - Show Ah at charge end ON/OFF
- Time and Date
  - daylight saving time / normal time
  - Predefined time zones
  - User-defined time zones

**Charging cable:**

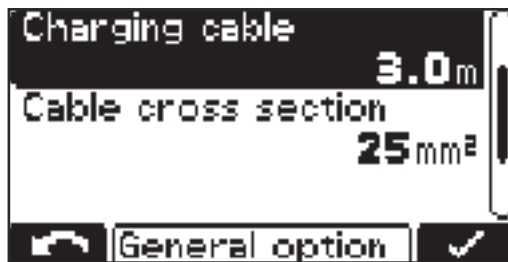

- Basic length of charging cable (m)

**Cable cross section:**

- Cross-section of the charging cable (mm<sup>2</sup>)

**AC current consumption:**

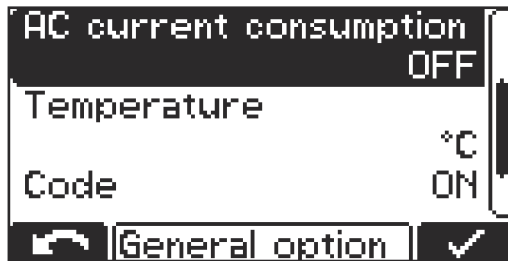

- Adapt the maximum consumed device current to the on-site electrical installation or the device connector fitted on the device.



- The minimum and maximum values differ depending on the different device classes. The minimum value is approx. 25% of the maximum nominal current of the charger.

**Temperature:**

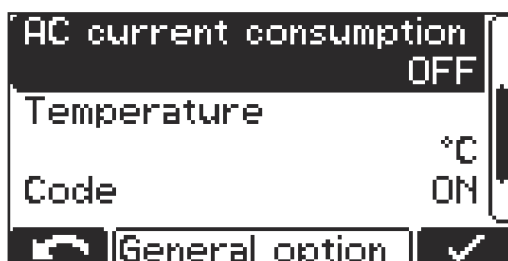

- Temperature in °C / °F

**Code:**

- Code entry required / not required to access configuration mode ("Code ON / OFF")

**USB Logging Time:**

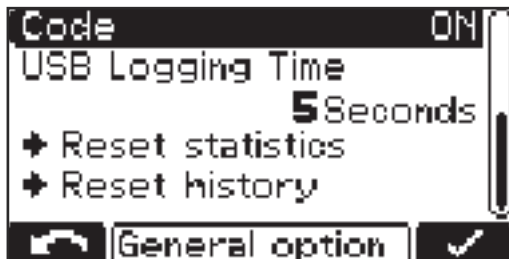

- Time interval (s) for recording charging parameters on the USB flash drive (USB Logging Time)

**Reset statistics**

**Reset history**

For more detailed information on the statistics and history, please refer to the "Statistics mode" and "History mode" sections.

---

**Reset settings**

The menu item offers 2 possibilities to reset all settings made:

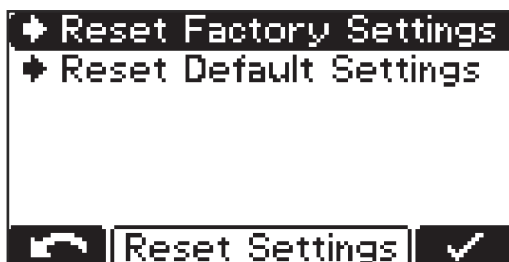

Reset Factory Settings:  
- Resets to factory settings.

Reset Default Settings:  
- Resets settings to the manufacturer's defaults.

---

**USB mode**

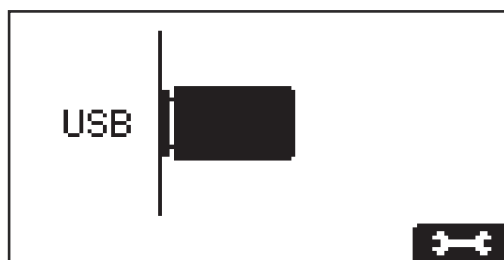

In USB mode, the display shows whether or not a USB flash drive is connected.

- The USB flash drive must conform to the following specifications:
- Formatting: FAT32
  - 32 Gigabyte maximum
  - No multiple partitioning

The I-SPoT VIEWER software supports the visualisation and evaluation of data on the USB flash drive. The I-SPoT VIEWER software can be found online at the following address: <http://www.fronius.com/i-spot>.

Only insert the USB flash drive when charging is not in progress or if the charging process has been interrupted.

If the charging process is only interrupted, not completed, it is only possible to read out data. A new update or configuration cannot be loaded.



1 Use the "Stop/Start" key to access the following settings



2 Use the "Up/Down" keys to scroll between the settings



3 Use the "Stop/Start" key to confirm the desired setting

A USB flash drive may be connected while charging is in progress, after the "Stop/Start" key has been pressed. However, this can only be to read out data. An update or new configuration cannot be loaded.

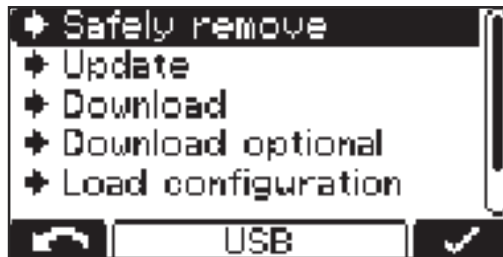

- **Safely remove**  
Safely remove the USB flash drive as soon as the desired action has been completed.
- **Update**  
A list of the suitable update files stored on the USB flash drive opens. Select and confirm the desired file in the same way as scrolling through the settings.  
Do not change the automatically assigned file names of the update file!
- **Download**  
The data relating to the logged charging parameters stored in the device's datalogger is saved to the USB flash drive for the I-SPoT VIEWER. Additionally, events - such as the device settings and user curves (configuration) - are saved.  
The following time ranges can be selected for the datalogger:
  - 1 month
  - 3 months
  - All
  - Since the last save
- **Download optional**  
The following options are available:
  - I-SPoT VIEWER  
The logged data is saved in the same way as for the "Download" function, but saving only the I-SPoT VIEWER data.
  - Save datalogger  
The logged data is saved in the same way as for the "Download" function, but is saved not in the I-SPoT VIEWER format, but as ".csv" files (Automatic folder structure for the ".csv" files: \*  
Fronius\  - Save events  
Events are saved to the USB flash drive.
  - Save configuration  
The device settings are saved to the USB flash drive.



- **Load configuration**  
Loads onto the device one of the suitable device configurations stored on the USB flash drive
- **Load dealer text**  
A text file can be loaded from the USB flash drive that is displayed as soon as the device enters an error state. The text file can, for example, contain the contact details of the dealer. The file must be saved on the USB flash drive as a ".txt" file in "unicode" format. The file name must be "dealer.txt". The number of characters is restricted to 99.
- \* If a USB flash drive is connected while charging is in progress, the .csv files are saved directly to the USB flash drive. The folder structure here is also created automatically and differs due to the presence of the "Datalog" folder instead of the "Charges" folder.

## Status codes

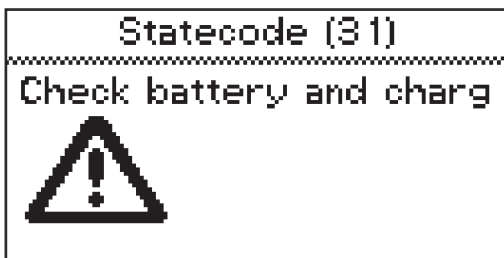

If a fault occurs during operation, specific status codes may be displayed. Faults can result from the following:

- Battery fault
- The voltage of the connected battery is unsuitable.
- The device has overheated.
- There is a software or hardware fault.

### Battery fault:

If the battery signals a fault, the battery charger displays this fault as a battery fault including the corresponding fault number for the battery. The respective fault is explained in the battery's operating instructions.

If an error message appears on the display and if you cannot resolve the error yourself:

- 1 Note the displayed status code: e.g. "Statecode (31)".
- 2 Note the configuration of the device.
- 3 Contact your authorised service centre.  
Freely-defined text, which could for example include the contact details of the distributor, can be displayed if the device is in an error state.

**Status codes caused by external factors**

<b>No.</b>	<b>Cause / Remedy</b>
(11)	Check mains voltage
(12)	Check mains (phase failure)
(13)	External temperature sensor faulty
(14)	Electrolyte circulation faulty (pressure switch not switching)
(15)	Control voltage not detected
(16)	External start/stop is not closed
(17)	Open circuit voltage detection triggered more than once during charging (e.g. worn charging contacts)

**Status codes in the event of a battery fault**

<b>No.</b>	<b>Cause / Remedy</b>
(22)	Battery undervoltage
(23)	Battery overvoltage
(24)	Battery too hot (with external temperature sensor only)
(25)	Battery too cold (with external temperature sensor only)
(26)	Cell fault detected
(27)	Battery not supported
(28)	Battery heavily discharged - safety charging is being carried out
(29)	Battery is connected with reverse polarity
(30)	Thermal runaway

**Status codes in the event of a charging error**

<b>No.</b>	<b>Cause / Remedy</b>
(31)	Timeout in I1 phase
(32)	Timeout in U1 phase
(33)	Battery overvoltage in the I2 phase
(34)	Ah exceeded
(35)	Timeout in I2 phase
(36)	Target voltage in I2 phase not reached (with format characteristic only)
(37)	Problem with RI charge
(38)	Set charging time cannot be reached
(39)	Timeout in RI charge



**Status codes in the event of a CAN fault (battery)**

<b>No.</b>	<b>Cause / Remedy</b>
(51)	Battery not responding
(52)	Battery data cannot be requested
(53)	Battery voltage not supported
(54)	Communication fault
(55)	Battery fault
(56)	Battery does not switch on
(57)	Message time limit exceeded
(58)	Registration failed

**Status codes in the event of a gateway fault**

<b>No.</b>	<b>Cause / Remedy</b>
(101)	Setting CAN Connect is active and no CAN connection to the gateway could be established for at least 2 minutes.
(102)	No gateway connection to the back-end.
(103)	Gateway is online but has registered no charger or another charger.

**Status codes in the event of a TagID fault**

<b>No.</b>	<b>Cause / Remedy</b>
(200)	Set technology on the battery charger is not compatible with the connected battery.
(201)	The nominal voltage of the battery is not supported by the battery charger or is prevented by a battery charger setting
(202)	The battery charger power is not high enough to charge the connected battery
(203)	CAN communication to TagID could not be established
(204)	TagID data could not be read
(205)	TagID update could not be performed
(206)	TagID temperature sensor is faulty
(207)	TagID voltage sensor is faulty
(208)	TagID battery master data is invalid or not available
(209)	Faulty EEPROM memory
(210)	Faulty flash memory
(211)	Invalid device signature
(212)	TagID data could not be written

(213)	The charger power is not sufficient to charge the battery in the desired charging time
(214)	Too much power dissipation on the DC path
(215)	TagID level sensor is mounted in the wrong cell or is faulty
(216)	TagID software crash

#### **Status codes in the event of a temperature monitoring fault**

<b>No.</b>	<b>Cause / Remedy</b>
(300)	Connection to the temperature sensor could not be established
(301)	Faulty temperature sensor
(302)	Temperature exceeded - temperature too high

#### **Status codes in the event of a fault in the primary circuit**

<b>No.</b>	<b>Cause / Remedy</b>
(500)	Module 1 (top) temperature sensor faulty
(501)	Module 2 (bottom) temperature sensor faulty
(502)	PCB temperature sensor faulty
(503)	Primary overtemperature
(504)	Fan blocked/faulty
(505)	Intermediate circuit over/undervoltage
(506)	Intermediate circuit imbalance
(507)	Primary supply voltage outside the tolerance
(508)	Power failure
(509)	Wrong device configuration
(510)	Primary EEPROM faulty
(527)	Phase shifter overcurrent
(528)	High charge relay switched off during load operation
(530)	Communication error
(532)	Microcontroller error (e.g. division by 0)
(533)	Reference voltage outside the tolerance
(534)	Start-up error
(535)	PFC overcurrent
(536)	Phase shifter or PFC faulty

**Status codes in the event of a fault in the secondary circuit**

<b>No.</b>	<b>Cause / Remedy</b>
(520)	Secondary temperature sensor faulty
(521)	Secondary overtemperature
(522)	Output fuse faulty
(523)	Secondary supply voltage outside the tolerance
(524)	Secondary reference voltage outside the tolerance
(525)	Current offset
(526)	Current offset outside the tolerance
(527)	Power module overcurrent (primary)
(529)	No secondary communication
(530)	No primary communication
(531)	Secondary EEPROM faulty
(532)	Microcontroller fault
(537)	Voltage measurement faulty
(570)	Secondary relay cannot be switched
(571)	ADC/SPI error

**Status codes in the event of a fault in the controller**

<b>No.</b>	<b>Cause / Remedy</b>
(540)	Configuration memory chip missing/faulty
(541)	No secondary communication
(542)	Secondary initialisation failed
(543)	Program/memory fault in characteristic control
(544)	Program/memory fault in characteristic control
(545)	Primary initialisation failed
(546)	Update failed
(547)	Load/save settings failed
(548)	Load/save characteristic settings failed
(549)	Charging could not be resumed after a power failure
(550)	Time not set
(551)	Hardware modification detected
(552)	Configuration memory chip invalid
(553)	Primary update failed
(554)	Fault in the communication
(555)	Incorrect device software

---

(557) Interruption of the InterLock communication

---

(558) The second device, which is connected via the InterLock option, has an error

---

(559) The second device, which is connected via the InterLock option, is incompatible with this device

---

# Options

---

## Safety

The housing has to be partially opened to connect the options.

### **WARNING!**

#### **Danger of electric shock.**

This may result in serious injuries or death.

- ▶ The housing must never be opened by anyone other than a service technician trained by the manufacturer.
  - ▶ Before working with the housing open, the device must be disconnected from the grid.
  - ▶ A suitable measuring device must be used to ensure that electrically charged components (e.g., capacitors) are completely discharged.
  - ▶ With the aid of a clearly legible, understandable warning sign, ensure that the device remains disconnected from the grid until all work has been completed.
- 

### **WARNING!**

#### **Danger due to work that is not carried out properly.**

This can result in severe personal injury and damage to property.

- ▶ All work involved with connecting optional components must only be carried out by service technicians trained by the manufacturer.
  - ▶ If there are Installation Instructions or User Information for the optional component concerned, then all warning notices and instructions therein must be obeyed.
  - ▶ For all options with electrical connections, a safety inspection must be carried out in accordance with the applicable national and international standards and guidelines after connection work has been carried out.
  - ▶ You can obtain more information about the safety inspection from the authorized service body.
  - ▶ The service body will provide the necessary documents upon request.
- 

## **Electrolyte circulation (not available with Selectiva 3x220 16 kW variants)**

The electrolyte circulation option has an air pump integrated into the battery charger. This delivers air into the battery via specially designed capillary tubes. This results in an intensive mixing of the electrolyte. The benefit is reduced battery heating, a longer battery life, and less water loss during charging.

The sequential control of the electrolyte circulation takes place via the battery charger control unit. Several selection options are available in the configuration menu for this purpose. Detailed information can be found in the [Additional functions](#) section of the "Display" chapter.

### **Cleaning the air filter insert**

Clean the air filter insert for the integrated air pump once a year. If there is a lot of dust, shorten the cleaning interval accordingly. It is necessary to remove the air filter insert (2) for cleaning purposes. Remove the air filter (1) by pulling it off and then reinstall it as follows:

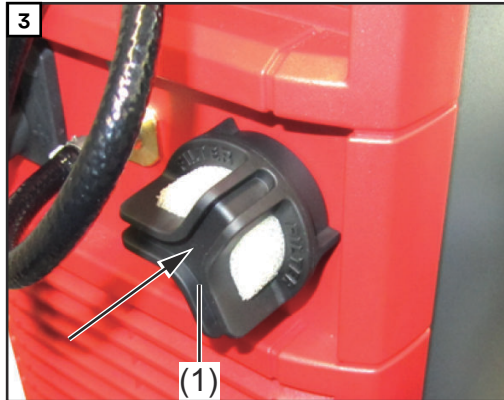
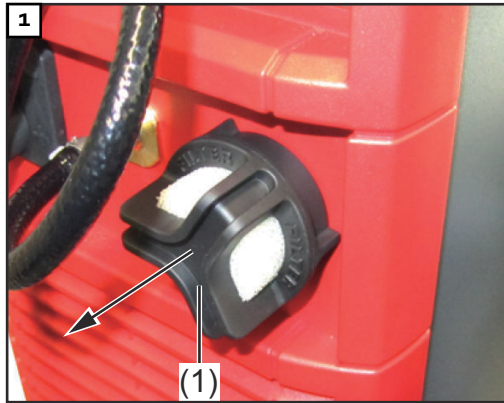

### External start/stop

The external start/stop option prevents spark formation at the charging plug if it is disconnected during charging. Special contacts inside the charging plug register a disconnection. These contacts are leading in comparison to the main contacts. An immediate charging stop is triggered. There is therefore no wear on the main contacts and the level of safety against oxyhydrogen ignition is increased.

### Charging lights

	RCS 3.0	Lights
(1)	1	12V
(2)	2	GREEN
(3)	3	YELLOW
(4)	4	RED
(5)		BLUE
(+)		Temp. Sensor
(-)		Ext. Start/Stop

**WARNING Hazardous Voltage**

Kondensator Entladezeit < 2 min.  
 Capacitor discharge time < 2 min.  
 Décharge de condensateur < 2 min.  
 Condensador tiempo de descarga < 2 min.  
 Condensatore tempo di scaricamento < 2 min.

Suitable signal lamps can be connected to the connections inside the device as illustrated in order to indicate the state of charge or operating status of the charger. Each signal lamp must have a working voltage of 12 V, and the total current drawn by all the lamps must not exceed 0.5 A. Connections (1) to (5) in the Figure are assigned as shown below. It is advisable to use the lamp colours shown below:

Connection	Function	Colour
(1)	12 V power supply	
(2)	Battery is fully charged	Green
(3)	On: battery is being charged Flashing: charging has been interrupted	Yellow
(4)	An error has occurred (common error)	Red
(5)	The battery has already cooled down and is ready for use	Blue

If the RGB setting (LED strip) is set in the menu, then connection 3 (YELLOW) is not supported. The normal setting (conventional signal lamp) or RGB (LED strip) for the "External Lamp" function is explained under "Additional functions" in the "Display" section.

### Temperature-controlled charging

The temperature-controlled charging option always adjusts the charging voltage according to the current temperature of the battery. This results in considerably longer battery-life, especially where batteries are used in cold stores.

### CAN card

#### **WARNING!**

#### **Danger from using the CAN card for safety-critical functions.**

This may result in serious injury and damage to property.

- ▶ Do not use the CAN card for safety-critical functions.

The optional CAN card enables the charger's operating statuses and the connected battery's state of charge to be evaluated externally.

More information on the CAN card can be found in the instructions supplied with the CAN card option.

#### **WARNING!**

#### **An electric shock can be fatal.**

Only trained service technicians may open the housing. This includes removing the connection plate. The device must be disconnected from the mains before starting any work with the housing open. A suitable measuring instrument must be used to ensure that electrically charged components (e.g. capacitors) are fully discharged. Use an easily legible and understandable warning sign to ensure that the charger is not reconnected to the mains supply before all the work has been completed.

**⚠ WARNING!**

**Work that is carried out improperly can cause serious injury or damage.**

Connection work on the device must only be carried out by qualified specialist technicians. If there are Installation Instructions or User Information for the optional component concerned, then all warning notices and instructions therein must be obeyed.

Once the connection work is complete, a safety inspection must be carried out in accordance with relevant national and international standards and directives. Further details on safety inspections can be obtained from your authorised service centre. They will provide you with any documents you may require on request.

The figure shows the connections in the CAN connection area. The CAN connection area is located behind the connection plate on the front of the device.

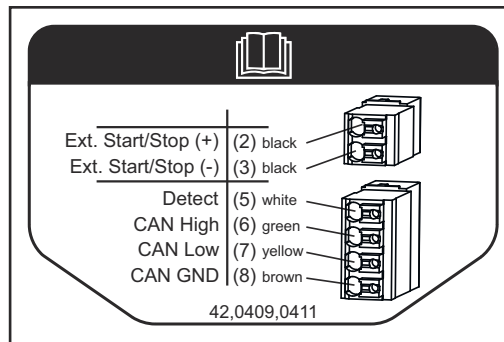

(2) External start/stop (+) - Black

(3) External start/stop (-) - Black

(5) Detect - White

(6) CAN High - Green

(7) CAN Low - Yellow

(8) CAN GND - Brown

**Relay board**

The optional relay board enables the external evaluation of the battery charger's operating states and the state of charge of the connected battery. It is also possible to supply one or more external loads with input voltage L-N. This requires an existing neutral conductor in the electrical network.

Enclosed is an overview of options directly related to the relay board. These relay board-specific options are controlled via the outputs of the relay board:



- Aquamatic control
- Charging
- Charge 50%
- Charge 80%
- Charge Finish
- Main Charge Finished
- Charge OK
- Charge Not Complete  
Signal if the battery is prematurely disconnected from the battery charger
- Common Error
- Common Error + Warning
- Signal Lamp
- Immobilizer Device
- ON
- Refill Indicator
- Battery Cooled
- External Air Pump (Electrolyte Circulation)

An explanation of the configuration for the outputs of the relay board can be found in the Operating Instructions for the battery charger: Chapter "Additional functions in configuration Mode" of the section **Additional functions**.

---

<b>Aquamatic control</b>	<p>The Aquamatic control contains the controller for a solenoid valve that automatically tops up the water in the battery to be charged.</p> <p><b>Standard setting</b></p> <ul style="list-style-type: none"> <li>- At the start of the recharging phase, the solenoid valve opens for 12 seconds and then closes for 4 seconds.</li> <li>- This cycle is repeated 26 times.</li> </ul> <p><b>USER setting</b></p> <ul style="list-style-type: none"> <li>- Configurable "ON" time (solenoid valve opens) after the end of the main charge phase.</li> </ul>
<hr/>	
<b>Charging</b>	<p>The "Charging" option is suitable for actuating a signal lamp for instance. While charging is in progress, the corresponding relay picks up automatically.</p>
<hr/>	
<b>Charge 50%</b>	<p>Like the "Main charge finished" function, the relevant relay switches as soon as the battery is 50% charged.</p>
<hr/>	
<b>Charge 80%</b>	<p>Like the "Main charge finished" function, the relevant relay switches as soon as the battery is 80% charged.</p>
<hr/>	
<b>Charging not complete</b>	<p>The "Charging not complete" option lends itself to the actuation of an audible alarm device, for example. If the battery is disconnected from the charger before the charging process is complete, the relay switches for an adjustable time of 1 to 10 seconds.</p>

---

<b>Charge finish</b>	The "Charge finish" option is suitable for actuating a signal lamp for instance. Once the configured charging characteristic is fully completed, the corresponding relay picks up automatically.
----------------------	--

---

<b>Main charge finished</b>	The "Main charge finished" option is suitable for actuating a signal lamp for instance. When the main charge phase finishes, the corresponding relay picks up automatically.
-----------------------------	--

---

<b>Common error message</b>	The "Common error message" option is suitable for actuating a signal lamp for instance. Each time an error is detected, the relevant relay picks up automatically.
-----------------------------	--

---

<b>Common error + warning</b>	In the same way as for the "Common error" function, the corresponding relay trips as soon as an error or warning is detected.
-------------------------------	---

---

<b>Signal lamp</b>	<p>As an alternative to the charging lights, one or more suitable lamps can be connected to the relay board to indicate the state of charge or operating status of the charger. These lamps can be designed for a voltage of up to 30 V DC or up to 250 V AC on a starpoint-earthed network.</p> <p>If the lamp circuit is potential-free, then the switching current must not exceed 4 A. A lamp that is actuated by the 230 V supply relay must be operated with an output current of max. 1 A.</p>
--------------------	---

---

<b>Immobiliser device</b>	<p>If the charger is built into a vehicle as an on-board device, the optional immobiliser device will prevent the vehicle from being started unintentionally whilst charging is taking place. This protects the vehicle, the battery and the charger leads from damage.</p> <p>As soon as the vehicle is connected to the mains supply, the corresponding relay picks up and blocks the ignition signal for instance. Another example is the actuation of a suitable signal lamp to convey the message visually that charging is currently in progress.</p>
---------------------------	---

---

<b>Battery cooled down</b>	The corresponding relay switches automatically once the time set in the menu has passed.
----------------------------	--

---

<b>External air pump - electrolyte circulation</b>	This option enables an external air pump to be activated by a relay contact in the sense of the "electrolyte circulation" option.
--	---

---

<b>Wall bracket</b>	The robust wall bracket ensures safe fitting on site. More information can be found in the corresponding Installation Instructions.
---------------------	---

---

<b>Floor bracket</b>	The robust floor bracket ensures safe fitting on site. More information can be found in the corresponding Installation Instructions.
<b>LED strip</b>	The LED strip acts as a status indicator and lights up in the same colours as the display elements on the control panel. An LED strip including a diffuser is installed in the gap between the front wall and upper part of the housing.
<b>IP 23</b>	The IP 23 option increases the IP protection rating of the device from IP 20 to IP 23. More detailed information can be found in the corresponding User Information.
<b>Air filter</b>	In dusty environments, the air filter prevents the inside of the device from becoming dirty. This avoids a possible reduction in power and other problems. Detailed information can be found in the corresponding User Information. Cleaning interval as required (manufacturer's recommendation: monthly)
<b>"Mobile" kit</b>	A carrying strap and handle improve the mobility of the device.
<b>Remote control system</b>	The remote control system allows full operation of the device from a distance of up to 30 m (98 ft., 5.1 in.). This option includes a complete control panel in an aluminum housing.

---

# Technical data

**Selectiva 16 kW  
220 V**

**⚠ WARNING!**

**Danger of electric shock due to a residual current can be fatal.**

Only use a type B residual current circuit breaker for the mains connection of the device.

Mains voltage (-10%/+30%) <sup>1)</sup> Optional:	3~ NPE 220 V/50/60 Hz 3~ PE 220 V/50/60 Hz
Mains fuse protection <sup>2)</sup>	32 A
Minimum mains lead cross section Selectiva 4120 Selectiva 4140/4160	4 mm <sup>2</sup> (0.0062 in. <sup>2</sup> ) 6 mm <sup>2</sup> (0.0093 in. <sup>2</sup> )
Duty cycle	100%
EMC device class	B
Protection class	I
Max. permitted mains impedance $Z_{max}$ on PCC <sup>3)</sup>	According to the "Device-specific data" table below
Degree of protection <sup>4)</sup>	IP 20
Overvoltage category	III
Operating temperature <sup>5)</sup>	-20°C to +40°C (-4°F to 104°F)
Storage temperature	-25°C to +80°C (-13°F to 176°F)
Relative humidity	max. 85%
Maximum altitude above sea level	3000 m (9842 ft)
Mark of conformity	according to rating plate
Product standard	EN 62477-1
Dimensions L x W x H	647 x 247 x 392 mm (25.47 x 9.72 x 15.43 in.)
Weight (with standard mains and charging leads)	34.84 kg (76.81 lb)
Degree of contamination	3

- 1) The device is approved for operation on neutral-earthed mains networks with a maximum outer conductor nominal voltage of 220 V.
- 2) Nothing other than a type B residual current circuit breaker should ever be used for connecting the device to the mains. The earth leakage current is less than 3.5 mA.
- 3) Interface to a 127/220 V and 50 Hz public grid.
- 4) For indoor use only, do not expose to rain or snow.
- 5) A high ambient temperature may result in power degradation (derating).

Device-specific data						
Device	Max. AC current	Max. AC power	Nominal voltage		Max. charging current	$Z_{\max}$
4120 3x220 16 kW	28.5 A	9070 W	48 V		120 A	203 mOhm
4140 3x220 16 kW	29.6 A	9390 W	48 V		140 A	183 mOhm
4160 3x220 16 kW	29.9 A	9490 W	48 V		160 A	156 mOhm

**Selectiva 8 kW  
400 V**

**⚠ WARNING!**

**An electric shock due to a fault current can be fatal.**

Nothing other than a type B residual current circuit breaker should ever be used for connecting the device to the mains.

Mains voltage (-10%/+30%) <sup>1)</sup> Optional:	3~ NPE 400 V / 50/60 Hz 3~ PE 400 V/50/60 Hz
Mains fuse protection <sup>2)</sup>	16 A
Minimum mains lead cross section	2.5 mm <sup>2</sup> (0.003875 in. <sup>2</sup> )
Duty cycle	100%
EMC device class	B
Protection class	I
Max. permitted mains impedance $Z_{\max}$ on PCC <sup>3)</sup>	None
Degree of protection <sup>4)</sup>	IP 20
Overvoltage category	III
Operating temperature <sup>5)</sup>	-20°C to +40°C (-4°F to 104°F)
Storage temperature	-25°C to +80°C (-13°F to 176°F)
Relative humidity	max. 85%
Maximum altitude above sea level	2000 m (6561 ft.)
Mark of conformity	according to rating plate
Product standard	EN 62477-1
Dimensions L x W x H	633 x 180 x 344 mm (24.92 x 7.09 x 13.54 in.)
Weight (with standard mains and charging leads)	23 kg (50.71 lb)
Degree of contamination	3

- 1) The device is approved for operation on neutral-earthed mains networks with a maximum outer conductor nominal voltage of 400 V. An L-N mains voltage tolerance of 207 V to 250 V applies for the electrolyte circulation and relay board options.
- 2) Nothing other than a type B residual current circuit breaker should ever be used for connecting the device to the mains.  
If the charger is protected by a 32 A fuse, the thermal stress of the automatic circuit breaker must not exceed 82000 A<sup>2</sup>s.  
The earth leakage current is less than 3.5 mA.
- 3) Interface to a 230/400 V and 50 Hz public grid.
- 4) For indoor use only, do not expose to rain or snow.
- 5) A high ambient temperature may result in power degradation (derating).

<b>Device-specific data</b>				
<b>Device</b>	<b>Max. AC current</b>	<b>Max. AC power</b>	<b>Nominal voltage</b>	<b>Max. charging current</b>
2100 8 kW	6.7 A	3860 W	24 V	100 A
2120 8 kW	7.8 A	4590 W	24 V	120 A
2140 8 kW	9.0 A	5350 W	24 V	140 A
2160 8 kW	10.1 A	6090 W	24 V	160 A
2180 8 kW	11.2 A	6860 W	24 V	180 A
2200 8 kW	12.3 A	7610 W	24 V	200 A
2225 8 kW	13.7 A	8560 W	24 V	225 A
4060 8 kW	7.3 A	4610 W	48 V	60 A
4075 8 kW	9.0 A	5710 W	48 V	75 A
4090 8 kW	10.6 A	6820 W	48 V	90 A
4090A 8 kW	10.4 A	6810 W	48 V	90 A
4120 8 kW	13.8 A	9050 W	48 V	120 A
4120A 8 kW	13.7 A	9040 W	48 V	120 A
4140 8 kW	14.4 A	9340 W	48 V	140 A
4140A 8 kW	14.3 A	9280 W	48 V	140 A
4160 8 kW	14.5 A	9390 W	48 V	160 A
4160A 8 kW	14.4 A	9370 W	48 V	160 A
4185 8 kW	15.3 A	9950 W	48 V	185 A
8040 8 kW	8.2 A	5000 W	80 V	40 A
8060 8 kW	12.0 A	7440 W	80 V	60 A
8060A 8 kW	11.8 A	7440 W	80 V	60 A
8075 8 kW	14.1 A	9110 W	80 V	75 A
8075A 8 kW	14.0 A	9110 W	80 V	75 A
8090 8 kW	14.2 A	9210 W	80 V	90 A
8090A 8 kW	14.1 A	9190 W	80 V	90 A
8110 8 kW	15.1 A	9740 W	80 V	110 A

**Selectiva 16 kW  
400 V**

**⚠ WARNING!**

**Danger of electric shock due to a residual current can be fatal.**

Only use a type B residual current circuit breaker for the mains connection of the device.

Mains voltage (-10%/+30%) <sup>1)</sup> Optional:	3~ NPE 400 V/50/60 Hz 3~ PE 400 V/50/60 Hz
Mains fuse protection <sup>2)</sup>	32 A
Minimum mains lead cross-section Selectiva 4210/8120/8140 Selectiva 8160/8180/8210	4 mm <sup>2</sup> (0.0062 in. <sup>2</sup> ) 6 mm <sup>2</sup> (0.0093 in. <sup>2</sup> )
Duty cycle	100%
EMC device class	B
Protection class	I
Max. permitted mains impedance $Z_{max}$ on PCC <sup>3)</sup>	According to the "Device-specific data" table below
Degree of protection <sup>4)</sup>	IP 20
Overvoltage category	III
Operating temperature <sup>5)</sup>	-20°C to +40°C (-4°F to 104°F)
Storage temperature	-25°C to +80°C (-13°F to 176°F)
Relative humidity	max. 85%
Maximum altitude above sea level	2000 m (6561 ft.)
Mark of conformity	according to rating plate
Product standard	EN 62477-1
Dimensions L x W x H	647 x 247 x 392 mm (25.47 x 9.72 x 15.43 in.)
Weight (with standard mains and charging leads)	36.8 kg (81.13 lb)
Degree of contamination	3

- 1) The device is approved for operation on neutral-earthed mains networks with a maximum outer conductor nominal voltage of 400 V. An L-N mains voltage tolerance of 207 V to 250 V applies for the electrolyte circulation and relay board options.
- 2) Nothing other than a type B residual current circuit breaker should ever be used for connecting the device to the mains. The earth leakage current is less than 3.5 mA.
- 3) Interface to a 230/400 V and 50 Hz public grid.
- 4) For indoor use only, do not expose to rain or snow.
- 5) A high ambient temperature may result in power degradation (derating).



<b>Device-specific data</b>					
<b>Device</b>	<b>Max. AC current</b>	<b>Max. AC power</b>	<b>Nominal voltage</b>	<b>Max. charging current</b>	<b>Z<sub>max</sub></b>
4210 16 kW	27.6 A	15860 W	48 V	210 A	107 mOhm
8120 16 kW	23.8 A	14830 W	80 V	120 A	96 mOhm
8140 16 kW	27.5 A	17270 W	80 V	140 A	82 mOhm
8160 16 kW	30.3 A	18150 W	80 V	160 A	74 mOhm
8180 16 kW	30.6 A	18260 W	80 V	180 A	67 mOhm
8210 16 kW	30.9 A	18430 W	80 V	210 A	67 mOhm







**Fronius International GmbH**

Froniusstraße 1  
4643 Pettenbach  
Austria  
[contact@fronius.com](mailto:contact@fronius.com)  
[www.fronius.com](http://www.fronius.com)

At [www.fronius.com/contact](http://www.fronius.com/contact) you will find the contact details  
of all Fronius subsidiaries and Sales & Service Partners.